

RADIO CRAFT



H-F BLIND-
LANDING PILOT
SEE PAGE 273

FEB

1945

25¢

CANADA 30¢

RADIO-ELECTRONICS IN ALL ITS PHASES

The Best
Show
On the Air
Saturday
Night!

"MEET YOUR NAVY"
Now Carries the RAYTHEON Name
into 3,500,000 Radio Homes Each Week!

Free!

Ask your Raytheon distributor
for colorful attention-getting
"Meet Your Navy" display to
tie in with this great program.
Easel-mounted, 17½ x 20½"



Every Saturday Night

ENTIRE BLUE NETWORK

Coast to Coast 181 Stations



RAYTHEON MANUFACTURING COMPANY

Waltham and Newton, Massachusetts



All Four Raytheon Divisions
Have Been Awarded Army-
Navy "E" with Two Stars

RAYTHEON

High Fidelity



ELECTRONIC AND RADIO TUBES

DEVOTED TO RESEARCH AND THE MANUFACTURE OF TUBES AND EQUIPMENT FOR THE NEW ERA OF ELECTRONICS

A FREE LESSON SHOWED BILL HOW HE COULD MAKE GOOD PAY IN RADIO!

BILL, YOU'RE ALWAYS FOOLING WITH RADIO--OUR SET WON'T WORK--WILL YOU FIX IT?

I'LL TRY, MARY. I'LL SEE WHAT I CAN DO WITH IT TONIGHT



I CAN'T FIND OUT WHAT'S WRONG -- GUESS I'LL MAKE A FOOL OF MYSELF WITH MARY



HELLO, BILL--GOT A TOUGH ONE TO FIX? LET ME HELP YOU



YES, JOE -- I'M STUMPED-- BUT SINCE WHEN ARE YOU A RADIO EXPERT?



I'VE BEEN STUDYING AT HOME WITH THE NATIONAL RADIO INSTITUTE. I JUST LANDED A SWELL RADIO JOB, TOO LISTEN FOR THE CLICKS AS I SHORT THE GRID CONNECTIONS... HERE'S YOUR TROUBLE IN THE FIRST I.F. STAGE-- I LEARNED THIS TEST BEFORE I EVEN STARTED THE COURSE, FROM A FREE LESSON THE N.R.I. SENT ME

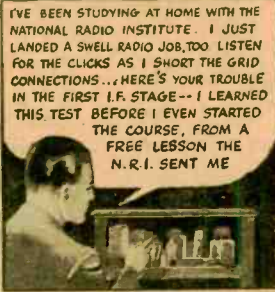

SAY, I'VE SEEN THEIR ADS BUT I NEVER THOUGHT I COULD LEARN RADIO AT HOME I'LL MAIL A COUPON FOR A FREE LESSON RIGHT AWAY



I'M CONVINCED NOW THAT THE N.R.I. COURSE IS PRACTICAL AND THOROUGH. I'LL ENROLL NOW. THEN I CAN MAKE EXTRA MONEY FIXING RADIOS IN SPARE TIME WHILE LEARNING



SOON I CAN HAVE MY OWN FULL-TIME RADIO REPAIR BUSINESS, OR BE READY FOR A GOOD JOB IN A BROADCASTING STATION AVIATION RADIO, POLICE RADIO OR SOME OTHER BUSY RADIO FIELD



YOU CERTAINLY KNOW RADIO. SOUNDS AS GOOD AS THE DAY I BOUGHT IT!

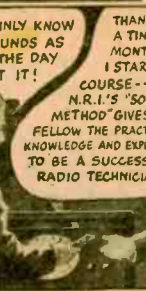

THANKS! I WAS JUST A TINKERER A FEW MONTHS AGO. BEFORE I STARTED THE N.R.I. COURSE-- BUT N.R.I.'S "SO-SO METHOD" GIVES A FELLOW THE PRACTICAL KNOWLEDGE AND EXPERIENCE TO BE A SUCCESSFUL RADIO TECHNICIAN



OH, BILL--I'M SO GLAD I ASKED YOU TO FIX OUR RADIO! IT GOT YOU STARTED THINKING ABOUT RADIO AS A CAREER, AND NOW YOU'RE GOING AHEAD SO FAST!



YES, OUR WORRIES ARE OVER I HAVE A GOOD JOB AND THERE'S A BRIGHT FUTURE FOR US IN RADIO

LATER

I will send you a Lesson on Radio Servicing Tips FREE TO SHOW HOW PRACTICAL IT IS TO TRAIN AT HOME FOR GOOD JOBS IN RADIO

I want to give every man who's interested in Radio, either professionally or as a hobby, a copy of my Lesson, "Radio Receiver Troubles—Their Cause and Remedy"—absolutely FREE! It's a valuable lesson. Study it—keep it—use it—without obligation! And with it I'll send my 64-page, illustrated book, "Win Rich Rewards in Radio." FREE. It describes many fascinating jobs in Radio, tells how N.R.I. trains you at home in spare time, how you get practical experience with SIX KITS OF RADIO PARTS I send.



This "sample" Lesson will show you why the easy-to-grasp lessons of the N.R.I. Course have paved the way to good pay for hundreds of other men. I will send it to you without obligation. MAIL THE COUPON!

Future Looks Bright for Well-Trained Radio Technicians, Operators

Many good pay opportunities are ahead for capable, well-trained Radio Technicians and Operators. The Radio Repair Business is booming. Profits are large and prospects are bright. Broadcasting Stations, Aviation and Police Radio, Loudspeaker Systems and Radio Manufacturers all give good jobs to trained radio men. And think of the NEW jobs that Television, Electronics, and Frequency Modulation will open up in the future!

Many Beginners Soon Make \$5, \$10 a Week EXTRA in Spare Time

As soon as you enroll for my Course I start sending you EXTRA MONEY JOB SHEETS that help show you how to earn \$5 to \$10 a week EXTRA in spare time while still learning.

Mail Coupon for Free Lesson and Book The opportunity now offered beginners to get started in Radio may never be repeated. So take the first step at once. Get my FREE Lesson and 64-page, illustrated book. No obligation. Just mail coupon in an envelope or paste it on a penny postal.—J. E. SMITH, President, Dept. 5BX, National Radio Institute, Pioneer Home Study Radio School, Washington 9, D. C.

You Build These and Other Radio Circuits with 6 BIG KITS OF PARTS I SEND YOU!

By the time you've conducted 60 sets of Experiments with Radio Parts I supply, made hundreds of measurements and adjustments, you'll have valuable PRACTICAL Radio experience for a good full or part-time Radio job!



SUPERHETERODYNE CIRCUIT (right) Preselector, oscillator-mixer-first detector, i.f. stage, diode detector—a.v.c. stage, audio stage. Vacuum tube multimeter, measures A.C., D.C., and R.F. volts, D.C. currents, resistance, receiver output.



MEASURING INSTRUMENT (above) you build early in Course. Use it in practical Radio work to make EXTRA money. Vacuum tube multimeter, measures A.C., D.C., and R.F. volts, D.C. currents, resistance, receiver output.

A. M. SIGNAL-GENERATOR (left) build it yourself! Provides amplitude - modulated signals for test and experimental purposes. Gives valuable practice!



GET BOTH 64 PAGE BOOK SAMPLE LESSON FREE

MR. J. E. SMITH, President, Dept. 5BX NATIONAL RADIO INSTITUTE, Washington 9, D. C. Mail me FREE, without obligation, Sample Lesson and 64-page book, "Win Rich Rewards in Radio." (No salesman will call. Please write plainly.)

Name
 Address
 City Zone State 14X1

Our 31st Year of Training Men for Success In Radio

My Radio Course Includes Training in TELEVISION • ELECTRONICS • FREQUENCY MODULATION

RADIO CRAFT

AND POPULAR ELECTRONICS

Incorporating
SHORT WAVE CRAFT TELEVISION NEWS
RADIO & TELEVISION

MEMBER
AUDIT BUREAU OF CIRCULATIONS

HUGO GERNSBACK, *Editor-in-Chief*
FRED SHUNAMAN, *Associate Editor*
I. QUEEN, *Editorial Associate*
ELMER FULLER, *Shortwave Editor*
A. PASCALE, *Production Manager*
G. ALIQUO, *Circulation Manager*
JOHN J. LAMSON, *Advertising Director*
ALFRED STERN, *Promotion Manager*

IN THE NEXT ISSUE

Signal Tracer and Multitester
Electronic Aids to Aviation
Electric Clock Repair Tips
Rewiring the Battery Radio
An Electrostatic Modulator

Published by Radcraft Publications, Inc.
Publication Office: 29 Worthington Street,
Springfield 3, Mass.

Editorial and Advertising Offices: 25 West
Broadway, Tel. RE2-9690, New York 7, N. Y.

Chicago Advertising Office: Radio-Craft, 520
North Michigan Avenue, Tel. Superior 7306,
Chicago 11, Ill.

Cleveland Advertising Office: 405 Erie Bldg.,
Cleveland, Ohio. Burdette Phillips, Manager.
Tel. Main 9645.

Los Angeles Office: Robt. H. Deibler & Associates,
403 W. Eighth St., Tucker 1579.
RADIO-CRAFT is published monthly on the
25th of the month preceding that of date;
subscription price is \$2.50 per year in U. S.
(In foreign countries, 75c additional per year
to cover postage; Canada, 50c additional.)
Special rates for members of the Armed Forces
in U. S., or those addressed by A. P. O. or F. P. O.
mail, \$2.00. Entered at the post office at
Springfield as second-class matter under the
Act of March 3, 1879. All communications
about subscriptions should be addressed to:
Circulation Manager, Radio-Craft, 29 Worthington
St., Springfield 3, Mass.

Notice of CHANGE of ADDRESS should
reach us at least one month in advance. When
ordering a change, please furnish an address
stencil impression from a recent wrapper if
you can. Address changes cannot be made
without the old address as well as the new.

Foreign Agents

London—Atlas Publishing and Distributing
Co., Ltd., 18 Bride Lane, Fleet St., London,
E.C. 4.

Melbourne—McGill's Agency, 179 Elizabeth
St., Australia.

Text and illustrations of this magazine are
copyright and must not be reproduced without
permission of the copyright owners.
Copyright, 1945, Radcraft Publications, Inc.

Contents February, 1945 Volume XVI, No. 5

Editorial: Awake, Radio Industry!..... by Hugo Gernsback 269
Radio-Electronics Monthly Review..... 270

AVIATION RADIO

A Primer of Aviation Radio..... by Raymond Lewis 272
Radio Pilot Lands Planes..... by S. R. Winters 273

ELECTRONICS

Super Photo-Timer..... 276
Photographing the Air..... 277
New FM Receiving System..... 279
Electronic Thickness Gage..... by Wesley S. Erwin 280
Luminescent Radios..... by M. A. Heikkila 281
Earthquake Recorder..... 287
Uses for the OA4-G Gas Tube..... by Nathaniel Rhita 288
Radio-Audience Meter..... by I. Queen 290

RADIO TRAINING

Cross-Over Networks..... by Jack King 286
Speech Amplifier, Part V..... by Robert F. Scott 289

SOUND

Noiseless Recording..... by I. Queen 274
Capacity Phono Pickup..... by Benjamin F. Miessner 282
Broadcast Equipment, Part VI..... by Don C. Hoefler 283
An Electronic Accompanist..... by Nathaniel Rhita 284

SERVICING

Record Changers..... by John Needre 286

CONSTRUCTION

Ultra Radio..... by Bob White 278

TEST INSTRUMENTS

Capacity Bridges..... by Alfred Thomson 275
Inverted Triode..... by W. A. Hayes 285

DEPARTMENTS

World-Wide Station List..... by Elmer R. Fuller 295
New Radio-Electronic Devices..... 296
Radio-Electronic Circuits..... 298
Try This One!..... 300
The Question Box..... 302
Progress in Invention..... by I. Queen 306
The Mail Bag..... 322
Technotes..... 324
Book Reviews..... 325

ON THE COVER



The cover this month shows a high-frequency electronic landing system for airplanes which has been used with considerable success. Horizontal and vertical radio beams, sent out by the ground apparatus, control apparatus in the plane. By watching a crossed-needle meter, the pilot may keep his plane horizontally and vertically in the path center.

how high is very high?

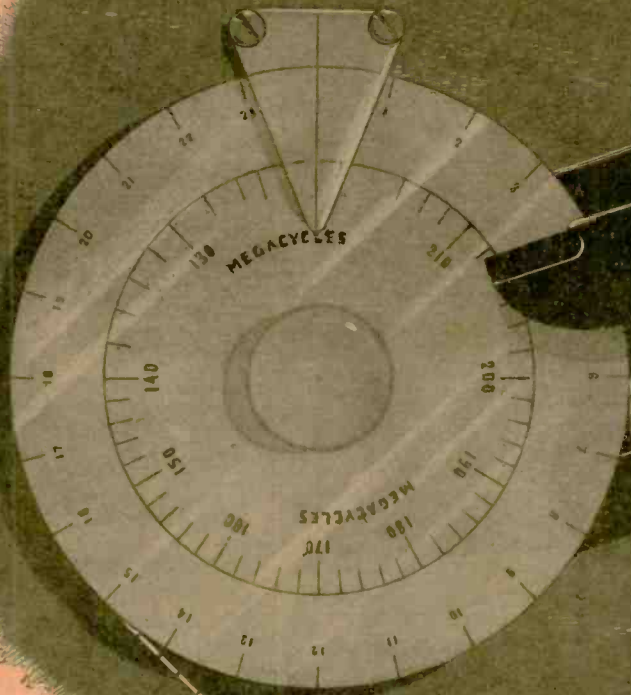

★ Engineers at Hallicrafters are continually striving for new heights of perfection in high frequency development work. The Model S-37 is one example of the progress they have made. This is the first and only set of its kind — covering both AM and FM and operating in the range of 130 to 210 Mc. Two r.f. stages are used and in conjunction with an intermediate frequency of 18 Mc., assure an amazingly high ratio of image rejection. It is becoming a valuable instrument in the hands of all exploring the upper reaches of the high frequency ranges.



Model S-37. The highest frequency range of any continuous-tuning commercial type receiver.

hallicrafters RADIO

THE HALLICTRAFTERS CO., MANUFACTURERS OF RADIO AND ELECTRONIC EQUIPMENT, CHICAGO 16, U. S. A.



Buy a War Bond Today!



RECIPE FOR "PRECISION-EL"

(MT. CARMEL STYLE)



Back to work with a smile—These men and women look forward to their jobs each day. They're Meissner's famed "precision-el." With many of them working to produce vital electronic equipment for the Armed Forces is a "family affair," for a place in this home front army of "precision-el" isn't restricted only to dad — mother, brother and sister contribute to the quality of Meissner products, too.



Splitting thousandths of an inch is all in the days work for this skilled machinist, yet he finds new reason to smile with each job done better. He, and hundreds like him, are responsible for the recognition of Meissner's "precision-el" by an exacting precision industry.

Take Mt. Carmel, Illinois, a typical American city, where men and women can work to produce and acquire the better things of life. Add pleasant and congenial working conditions like those you'll find at Meissner, exacting jobs like those you'll find in electronics — wait for the smile that means pride in a precision piece of work well done, and — presto — there you have it — "precision-el."

The men and women whose progress is shown on these pages are typical of Meissner famed "precision-el." Look at them. You'll find them just one more reason why Meissner products, precision built by "precision-el," do your job better.



"Precision-el" at work—still smiling, intent on the job at hand. Now it's a job that will bring victory nearer . . . After victory, it will be a job that makes for better living. Always, it's a better job, thanks to the smile that's always there.



Easy Way To "Step Up" Old Receivers!

Designed primarily as original parts in high-gain receivers, these Meissner Ferrocart I. F. Input and Output Transformers get top results in stepping up performance of today's well-worn receivers. Their special powdered iron core permits higher "Q" with resultant increase in selectivity and gain. All units double-tuned, with ceramic base, mica dielectric trimmers, thoroughly impregnated Litz wire, and shield with black crackle finish. Frequency range, 360-600. List price, \$2.20 each.

MEISSNER

MANUFACTURING COMPANY • MT. CARMEL, ILL.

ADVANCED ELECTRONIC RESEARCH AND MANUFACTURE

Export Division: 25 Warren St., New York; Cable: Simontrice

RADIO-CRAFT for FEBRUARY, 1945

SPRAYBERRY RADIO TRAINING

Gives you Both



FULL RADIO SET SUPPLIED FOR SHOP PRACTICE!

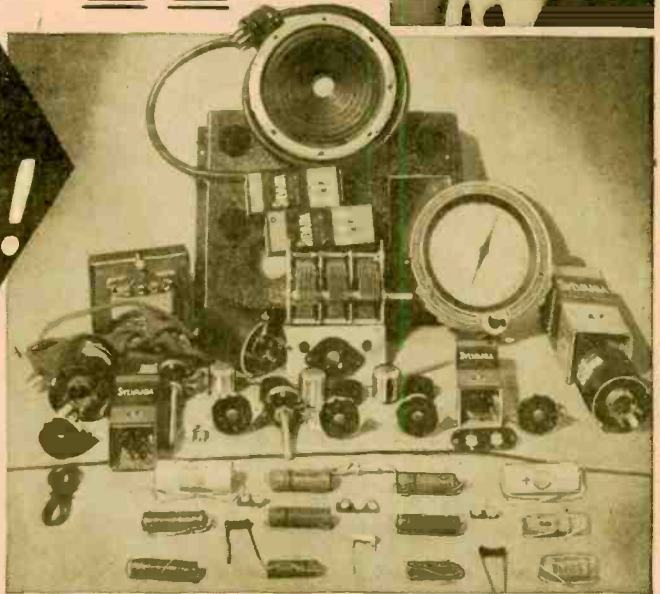

HERE'S THE ONE PRACTICAL WAY TO TRAIN FOR BIG EARNINGS AHEAD IN RADIO-ELECTRONICS & TELEVISION

The offer I make you here is the opportunity of a lifetime. It's your big chance to get ready for a wonderful future in the swiftly expanding field of Radio-Electronics INCLUDING Radio, Television, Frequency Modulation and Industrial Electronics. Be wise! NOW'S the time to start. No previous experience is necessary. The Sprayberry Course starts right at the beginning of Radio. You can't get lost. It gets the various subjects across in such a clear, simple way that you understand and remember.

I'll Show You a New, Fast Way to Test Radio Sets Without Manufactured Equipment

The very same Radio Parts I supply with your course for gaining pre-experience in Radio Repair work may be adapted through an exclusive Sprayberry wiring procedure to serve for complete, fast, accurate Radio Receiver trouble-shooting. Thus under Sprayberry methods you do not have one cent of outlay for manufactured Test Equipment which is not only expensive but scarce.

Prepares You For a Business of Your Own or Good Radio Jobs . . . Civilian or Military

My training will give you the broad, fundamental principles so necessary as a background no matter which branch of Radio you wish to specialize in. I make it easy for you to learn Radio Set Repair and Installation Work. I teach you how to install and repair Electronic Equipment. If you enter the Army, Navy or Marines, my training will help you win higher rating and better pay.

JUST OUT! FREE! HOW TO READ RADIO DIAGRAMS AND SYMBOLS

... a valuable new book which explains in simple, non-technical English how to read and understand any Radio Set Diagram. Provides the quick key to analyzing any Radio circuit. Includes translations of all Radio symbols. Send for this FREE book now while supply lasts and along with it I will send you another big FREE book describing my Radio-Electronic training.



GET FREE BOOKS

SPRAYBERRY ACADEMY OF RADIO
F. L. Sprayberry, Pres.
Box 500-TO
Pueblo, Colorado

Please rush my FREE copies of "HOW TO MAKE MONEY IN RADIO ELECTRONICS and TELEVISION," and "HOW TO READ RADIO DIAGRAMS and SYMBOLS."

Name Age

Address

City State

Tear off this coupon, mail in envelope or paste on Penny postcard.

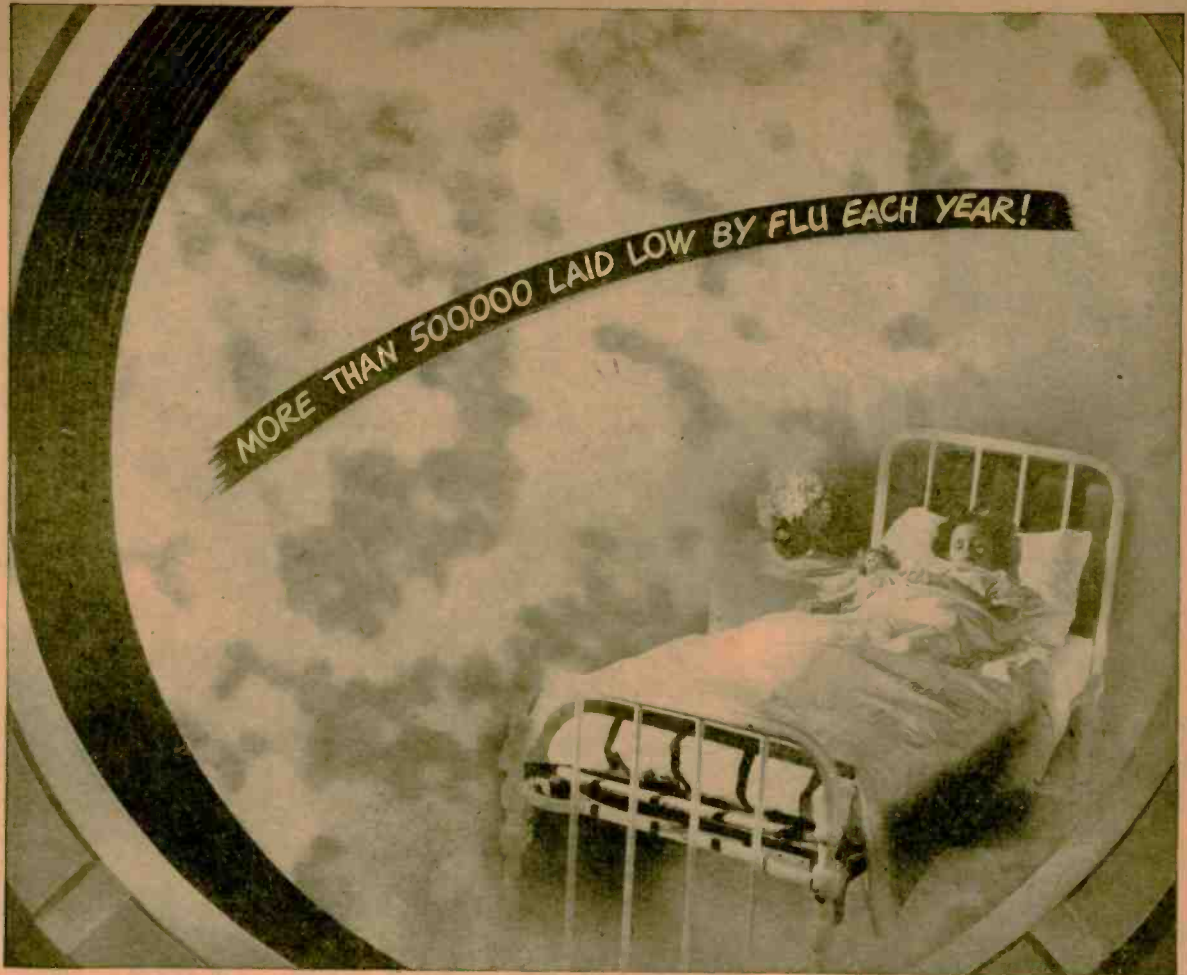

to destroy 'em you have to see 'em

Microscopes are gunsights in Medicine's battle on bacteria.

Optical microscopes, however, were not powerful enough to "draw an accurate bead" on the deadly virus that caused influenza.

But today, medical men have seen what no optical microscope could bring into focus—the infinitesimal influenza virus that previously had lain craftily camouflaged among larger cells.

This revelation came about through the Electron Microscope, developed by scientists at RCA Laboratories. And now, having been seen, influenza may be forced to unconditional surrender, saving the lives of thousands each year.

Here is but one facet of the genius shown by scientists behind RCA research . . . the

"ever-onward" research that saves lives or creates a better radio with equal skill . . . the "there-when-you-need-it" research that gave super-secret equipment to the United Nations . . . the "way-ahead" research that goes into everything made by RCA.

When you buy an RCA radio or phonograph or television set or any RCA product, you get a great satisfaction . . . enjoy a unique pride of ownership in knowing that you possess the very finest instrument of its kind that science has yet achieved.



They see what human eyes have never seen before!

Drs. Arthur Vance and James Hillier, scientists at RCA Laboratories, with Mr. E. W. Engstrom, Research Director (standing), examine the RCA Electron Microscope that has useful magnification up to 100,000 diameters, revealing unseen new worlds to the eyes of man.

RADIO CORPORATION of AMERICA

PIONEERS IN PROGRESS



Now You can Use.



ALL OF THESE RADIO PARTS

to help You learn

RADIO

FASTER-EASIER AT HOME

YOU CAN BUILD **133** FASCINATING EXPERIMENTS.

You get *both* radio parts and "Learn-by-Seeing" movies to help you grasp the fundamentals of Radio-Electronics faster . . . easier . . . from DeForest's. Send for DeForest's big, free book "VICTORY FOR YOU!" Learn how—at home—in your spare time—you get real Radio experience with these many Radio parts and sub-assemblies. DeForest's practical equipment system (as pictured above) saves time . . . speeds experiments. You quickly build Radio Receiving Circuits that work . . . a device for Light Beam Transmission, Electric Eye Circuits, a Radio Telephone, and scores of other fascinating projects. Learning Radio at home is practical, effective, and so interesting—with DeForest's "Home Laboratory."

YOU ALSO USE "LEARN-BY-SEEING" MOVIES

Think of the help you can get from the use of this genuine DeVRY Motion Picture Projector and exciting Radio TRAINING FILMS. You'll likely be surprised how much faster . . . easier . . . home movies can help you understand the fundamentals of Radio. SEE the principles of what you're learning—in action, ANIMATED! Peer into moving parts otherwise hidden from the eye.

**DeFOREST'S HOME MOVIES HELP YOU
LEARN FASTER—EASIER**



See Radio Circuits in Action—
Electrons on the March—with
this genuine DeVRY Projector

DeFOREST'S TRAINING, INC.
CHICAGO 14, ILLINOIS

You build and operate these interesting Radio-Electronic circuits in your own home:

- 5 Tube Superheterodyne Radio Receiver . . . Long-Wave Aviation Bond Radio Receiver . . . Short-Wave Radio Receiver . . . Radio Telephone . . . Wireless Microphone . . . Photo Electric Cell Control . . . Vacuum Tube Voltmeter . . . Public Address System . . . Hearing Aid Amplifier . . . Intercommunicating System . . . Radio Code Transmitter . . . Electron Coupled Oscillator . . . Tuned Radio Frequency Receiver and many other projects.

You get the big Radio home-training advantage of movies—exclusively from DeFOREST'S. So act now! Mail the coupon today!

YOU GET "ALL THREE" WITH DeFOREST'S

Where else can you get such a combination of *proved major* training features as—(1) 90 modern, loose-leaf lessons prepared under the supervision of Dr. Lee DeForest, often called the "Father of Radio;" (2) the use of "Learn-by-Seeing" home training films and a genuine 16mm. DeVRY movie projector; and (3) the use of many Radio parts to build 133 practical radio experiments in leisure time.

YOU BE THE JUDGE

See how DeForest's Training has helped many to good pay jobs in Radio-Electronics—others to preferred military classifications—still others to interesting, profitable businesses of their own. See how you can prepare for a bright future now—in your spare time at home—then get started in Radio-Electronics with the help of DeForest's effective EMPLOYMENT SERVICE.

Mail the coupon below for illustrated book "VICTORY FOR YOU"—also colorful Kit Supplement. *You be the judge.* No obligation. Mail the coupon today.

**DeFOREST'S TRAINING INCLUDES
INSTRUCTION IN MOTION PICTURE
SOUND EQUIPMENT, FM RADIO
AND TELEVISION**



DeFOREST'S TRAINING, INC., Dept. RC-B2
2535-41 N. Ashland Ave., Chicago 14, Illinois, U.S.A.

Please send me—FREE and WITHOUT OBLIGATION—illustrated book, "VICTORY FOR YOU," showing how I can prepare for Radio with your Home Movies and Laboratory Kits.

Name..... Age.....

Address.....

City..... State.....

If a Veteran of World War II, check here.



Centralab

SELECTOR SWITCHES

Your Jobber

is again in a position to supply servicemen and experimentors with either standard, completely assembled and individually cartoned selector switches or in kit form.

Available in two forms of insulation, i. e.; steatite or bakelite.

All switches have double-wipe contact terminals for long life and have a consistently low contact resistance of less than $2\frac{1}{2}$ milliohms and are completely self-cleaning. Index is positive with 30° between each rotating position.

Switches are also available for transmitter use.

Send for illustrated Catalog No. 24

Centralab

Division of GLOBE-UNION INC., Milwaukee
Producers of Variable Resistors—Selector Switches —
Ceramic Capacitors, Fixed and Variable—
Steatite Insulators.



KEEP UP WITH RADIO TELEVISION and ALLIED ELECTRONICS

Get in on the new developments in the fast expanding Radio Industry. Take your place in the field of Television. Make more money as a Modern Service Expert. Own and operate Your Own Business. Learn the latest Trade Secrets and Short Cuts through

SHOP METHOD HOME TRAINING

Don't waste time! Radio, F.M., Video (television), and the whole field of Electronics is changing fast. If you are in the radio business now you know what you are up against—new methods, new techniques, new equipment. Today you must solve NEW problems in servicing and repairing F.M. receivers. Tomorrow there will be thousands of Television Receivers to handle. Right after the war science promises NEW Electronic devices for household, factory and business. **THIS MEANS NEW OPPORTUNITY FOR YOU IF YOU ARE READY.** The thing to do is to GET READY. Find out about the marvelous new method of preparation—SHOP METHOD HOME TRAINING. Fill out and send in the coupon now.

Keep in Step With Shop Progress
Here is the truly modern system of training. It matches the RAPID PROGRESS CONSTANTLY BEING MADE in Radio, Television and Electronics. It is up to date in every way because it comes right from the busy radio training shops of National Schools where experiments and developments are being carried on—where discoveries are being made all the time.
It is based on real shop methods—on the handling of real shop jobs. Only National can offer you SHOP METHOD HOME TRAINING because only National has the big busy shops to develop this method.
And it is time tested too. National Schools has been training men for industry, for government, for business for more than a third of a century. In essence you get at home

—in your free time—the very same kind of instruction that has helped thousands upon thousands of ambitious men to more pay and greater opportunity—that has set thousands of men up in business with little or no capital. You owe it to yourself to read the book, "Your Future in Radios"—sent to you FREE if you fill out and mail the coupon.

Make Extra Money Right from the Start
You get ahead fast with National Training. Many beginners make good money on the side fixing radios and doing service work. You can turn your knowledge into cash after the first few lessons. Progress is rapid. You can actually SEE YOURSELF GET AHEAD, because the National Shop Method is so sound and practical.

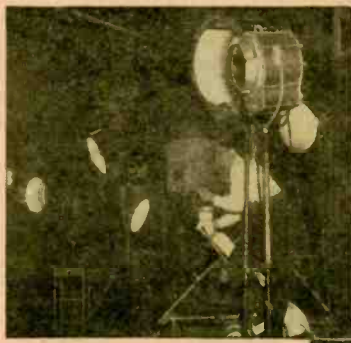

Get the Real Experience Before You Tackle a Job

Walk into a brand new job and go to work with assurance—the assurance that comes with knowing how—with working with and operating actual electronic equipment sent to you from the laboratories and shops of National Schools. There's nothing to equal learning by doing. In your National training you build real sets—a super-heterodyne receiver, a signal generator—literally scores of various electronic devices with your National equipment. Learn basic principles—FIRST THINGS FIRST. Get your knowledge and experience first hand under the personal guidance of seasoned, practical National instructors working personally with you. You know the very how and why of Radio—Television, Electronics.

Not only do you gain marvelous actual experience by this method of learning but you have valuable equipment you will use on the job in the practice of your profession as an electronics expert. Mail the coupon and learn what this means to you.

After the War What?

Face realities now! Is the job you're doing going to last? What is its future and yours? How are you going to meet conditions when the world returns to civilian production? There's no use in fooling yourself. Radio is a BIG, SOUND, WELL ESTABLISHED BUSINESS.

There are millions of sets in the country that need reconditioning right now. There is a big demand for millions more that have to be built—largely by trained men. F.M. is here to stay. BUT RADIO IS ONLY ONE FIELD OF ELECTRONICS. Television is sure to come. Sets must be built, installed, serviced and repaired. Who's going to do it? Make up your mind that you are—and at a great big profit—for years to come.

When you hang up your uniform—when your war job folds up will you step out proudly into a new field—an essential established industry—perhaps into a business of your own?



The above pictures were made in and around a modern television studio. Think what new opportunity is open to you in this great new field if you are ready for it. Prepare now. National training includes a good foundation in Television and F.M. Get the facts. Send the Coupon.

All This Modern Electronic Equipment and More Comes to You as Part of Your National Course



Get this FREE Lesson

Get a FREE lesson from National. Study it over at your convenience. See for yourself how thorough, how sound and how practical—yet how amazingly easy it is to learn and understand. NO SALESMAN WILL CALL ON YOU FROM NATIONAL SCHOOLS. National points out the opportunity—offers you the training and experience, prepares you for greater things in life. But it is up to you to act for yourself. And the first step is to fill out the Coupon and mail it. Get FREE lesson, the big Radio Book, and then decide.

NATIONAL TRAINING MEN NOW MAKING THE BEST MONEY IN HISTORY

The real value of National training shows up in the quick progress our men make on the job. Joe Grumlich of La Kea Hiawatha, N. J., turned down a job most men would welcome. He writes: "My latest offer was \$5,500.00 as radio photo engineer, but I am doing well where I am now engaged. I am deeply indebted to National."
Ely Bergman, now on Station WOR, told us: "My salary has been boosted considerably and at the present time I am making over \$2,000.00 per year, thanks to National Training." And from the far-off Hawaiian Islands, Wallace Choi sends this: "I am averaging \$225.00 a month. I will say that I honestly owe all this to the excellent training I had at National."

National is proud of the progress graduates are making all over the world. Read about their records yourself in the books we send you FREE.

NATIONAL SCHOOLS

LOS ANGELES 37, CALIFORNIA EST. 1905

MAIL OPPORTUNITY COUPON FOR QUICK ACTION

National Schools, Dept. 2-RC (Mail in envelope or paste on penny post card)
4000 South Figueroa Street, Los Angeles 37, California

Mail me FREE the two books mentioned in your ad including a sample lesson of your course. I understand no salesman will call on me.

NAME AGE

ADDRESS

CITY STATE

Include your zone number

NEW EDITION
NOW READY

Audels RADIOMANS GUIDE

Includes **TELEVISION
AND ELECTRONICS**

LARGER - MORE COMPLETE - 914 PAGES - 633 ILLUSTRATIONS - WIRING DIAGRAMS - PHOTOS

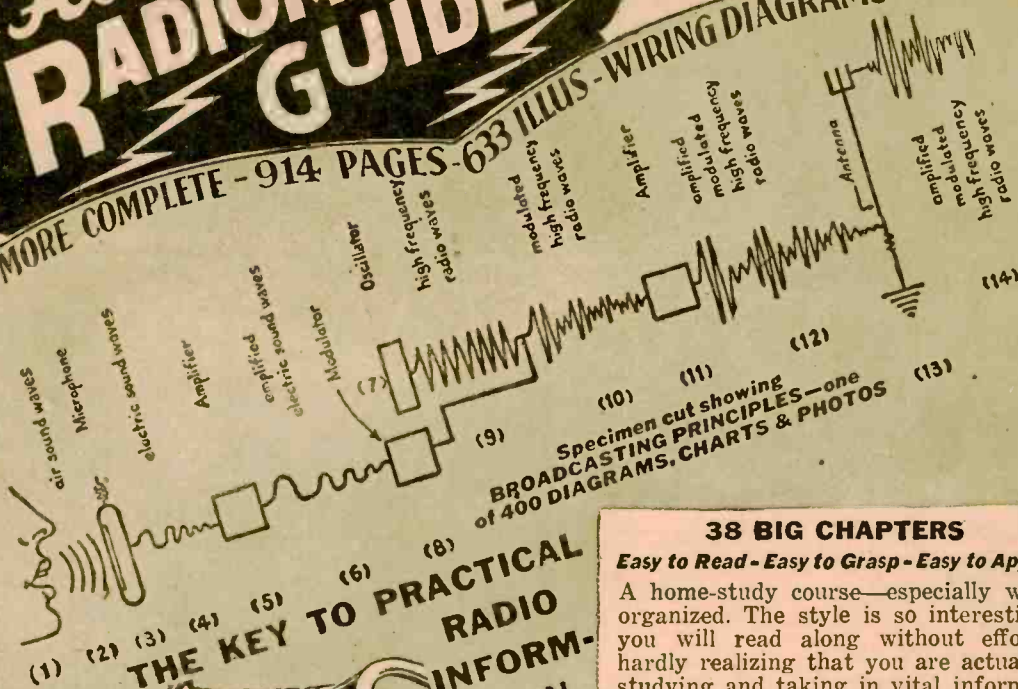

THE KEY TO PRACTICAL
RADIO
INFORMATION

It gives you in usable form pointers on radio, including frequency modulation, television, etc. Also valuable inside information for Aviators, Marines, Commercial Operators and Technicians, Servicemen and Students.



**Q AND A
UNIQUE
QUESTION
and
ANSWER
METHOD**

Highly Endorsed

1001 RADIO FACTS AND FIGURES
A Complete Library In One Book

AUDELS RADIOMANS GUIDE gives authentic Principles and Practices in Construction, Operation, Service and Repairs. Covers clearly and concisely radio fundamentals—Ohm's Law—Physics of sound as related to radio science—Measuring instruments—Power supply—Resistors—Inductors—Condensers—Transformers and examples—Broadcasting stations—Radio Telephony—Receivers—Diagrams—Construction—Control Systems—Loudspeakers—Antennas—AutoRadio—Phonograph Pick-ups—Public Address Systems—Aircraft and Marine Radio—Radio Compass—Beacons—Automatic Radio Alarms—Short Wave—Coil Calculations—Testing—Cathode Ray Oscillographs—Static Eliminations—Trouble Pointers—Underwriter's standards—Units and tables. REVIEW QUESTIONS—READY Reference Index.

38 BIG CHAPTERS

Easy to Read - Easy to Grasp - Easy to Apply

A home-study course—especially well organized. The style is so interesting you will read along without effort, hardly realizing that you are actually studying and taking in vital information. Audels Radiomans Guide gives you just the right amount of mathematics required to cope with radio problems successfully. You can solve, with the aid of this extraordinary book, practically every radioproblem that comes up. At your finger tips is a complete index for instant use.



7 DAYS' FREE TRIAL

THEO. AUDEL & CO., Publishers
49 West 23rd Street, New York 10, N. Y.

Mail AUDELS NEW RADIOMANS GUIDE for free examination. If O. K. I will send you \$1 in 7 days; then remit \$1 monthly until \$4 is paid. Otherwise I will return it.

Name _____
Address _____
Occupation _____
Reference _____

4 COMPLETE
1 PAY ONLY
MO.

MAIL THIS COUPON TODAY

Awake, Radio Industry!

... The radio industry is still chasing butterflies and continues in confounding the public with Post-war claims which are not likely to be fulfilled for years ...

HUGO GERNSBACK

ONE and one-half years ago in the September, 1943 issue of RADIO-CRAFT I stated as follows:

"Supposing that by extraordinary good luck the war should be over by the end of 1946; will all the impatient radio customers have their new-fangled radio sets in January, 1947? The answer is a categorical 'No'."

I have not felt it necessary to revise this forecast, indeed if anything, it was too optimistic and there is very little likelihood now that we will see the termination of the war by the end of 1946.

It is high time that the radio manufacturing industry should recognize conditions as they really are and stop all wishful thinking in regard to the near future. A realistic view—based on the following sober facts—should be taken for the next five years.

¶ 1. The war is certain not to be over for several years to come. Even with Germany finally out of the struggle, the war with Japan still will tax the efforts of this country with a very heavy load.

¶ 2. Radio manufacturers will not be permitted to make huge quantities of radio and television sets for public consumption till Germany is completely out of the war. Even that doesn't mean the end of hostilities in Europe, because a large part of our present armies will remain tied up in Germany and elsewhere for a long time to come. This will of necessity require much radio equipment which the radio industry must continue to supply.

¶ 3. As long as the Japanese war is in progress, facilities of radio manufacturers will be so heavily taxed that the civilian radio output for regulation radio sets, FM receivers and television receivers will be moderate. It is certain that for years the combined civilian output of all the radio manufacturers will only be a fraction of what it was in pre-war years. The Japanese war has just be-

gun in earnest. Due to the tremendous distances to be covered and the large areas over which our men will have to fight, it is certain that the amount of radio equipment needed by the Army, Navy and the Air Forces will *increase* rather than decrease for some time to come.

¶ 4. Even the termination of the war with Japan will not bring full-scale civilian radio-set manufacture immediately. As with Germany, so it will be with Japan—large armies will be tied up in the Pacific and the Asiatic mainland and elsewhere for some years to come. This means a huge output of radio matériel for a long time. That in turn precludes a huge civilian radio output comparable to that of the pre-war period.

It should be remembered that war radio matériel becomes antiquated with astonishing rapidity. What was the last word in war-radio two years ago, is obsolete today. Much of it therefore must be continuously replaced as the art progresses. Consequently the war load on the radio manufacturing industry will not diminish greatly for some years to come.

¶ 5. Summing up, it will be seen that **CIVILIAN RADIO SETS ARE NOT JUST AROUND THE CORNER**. The public should be made to fully understand this situation. For that reason manufacturers should stop publicizing fantastic post-war radio sets, which are only calculated to hurt the industry in the end. As pointed out in our last month's editorial, due to adverse publicity, because of impossible post-war radios, manufacturers have succeeded in unselling the public at large on radio. *A recent survey now places radios in the sixth place*. People first want washing machines, electric irons, refrigerators, electric cook stoves, toasters followed by radios. The electrical industry has not glamorized washing machines nor their other appliances. For that reason the public feels that these can be safely bought but will not attempt to buy home radios as long as conditions are as chaotic as they are now.

Radio Thirty-Five Years Ago

In Gernsback Publications

HUGO GERNSBACK
Founder

Modern Electrics	1908
Electrical Experimenter	1913
Radio News	1919
Science & Invention	1920
Radio-Craft	1929
Short-Wave Craft	1930
Wireless Association of America	1908

High Frequency Oscillations.
A Tuning Transformer, by *Richard H. Foster*.

Some of the larger libraries in the country still have copies of Modern Electronics on file for interested readers.

Simple Device for Wireless Beginners, by *Ray Page*.

Selective Detector Board, by *R. Fulton Adams*.

Wireless vs. Long Distance Telephone and Telegraph.

Common Telephone Receivers for Wireless, by *George M. Brown*.

Simple Silicon Detector.

A Variable Sending Condenser, by *Fred Wadsworth*.

Improved Silicon Detector.

Simple Wehnelt Interrupter, by *D. Adams*.

FROM the February, 1910 issue of MODERN ELECTRICS:

Dr. deForest's New Radio Telephone.
Portable Receiving Set, by *Edward Featherstone*.

The New Rossi Detector, by *A. C. Marlowe*.

A Pocket Wireless, by the *Brussels Correspondent*.

Electrolytic Detector Operates Relay.

Duplex Wireless (Marconi).

New High Frequency Device.

An Efficient Sending Condenser, by *Maurice Friedman*.

"IMPOSSIBILITIES" were the order of the day for the radio industry during 1944, declared Brigadier-General David Sarnoff in a year-end statement. From the viewpoint of 1940, he said, electronic techniques and services of last year were in the realms of the undreamed-of.

The most outstanding developments were devices for the armed services. There is little that can be told about them, said the RCA president. One not on the secret list is a 300-megacycle television transmitter able to put out power in excess of five kilowatts. This large output on high-frequency is due to the creation of a special tube. The new television broadcaster is now being perfected at RCA's laboratories, and waits only the end of the war to go into use.

The Brigadier-General's interest in, and enthusiasm for television is easily explained, as he was one of the earliest to promote the idea of television broadcasting in this country. He was hailed as the father of American Television by the Television Broadcasters Association in a ceremony at their recent conference in which he was given their chief award of merit. He is equally interested in other and newer branches of the electronic art, one of the chief of them being electronic control.

"Man has long dreamed of using radio to start, steer, control and operate aircraft, tanks, torpedoes, automobiles, boats and other objects," said Sarnoff. "With uncanny manipulation of electronics, wartime research has made some of these dreams come true. Man has achieved radio control over wheels, rudders, wings and guns. Rockets no longer move only as phantoms of imagination.

"Today, only mention can be made of the magic term radar. It is, however, only one of the great wartime developments of science. When we see radiophotos in the news of Japanese battleships afire from stem to stern under direct hits by 1000-pound bombs, we may wonder what part radio had in the triumph. When we read of fighter-bombers, dropping 500-pound bombs on industrial centers of the enemy, and accurately hitting their targets, we may wonder again what part radio played in the invisible yet accurate thrusts.

"When peace comes it will find, as it has at the end of every war, new inventions awaiting to be applied to every-day life, to bring new services of safety and comfort, entertainment and education."



Brigadier-General David Sarnoff receives the Television Broadcasters' medal from Paul Raiborn.

Radio-Electronics

Items Interesting

UNDERGROUND radio receivers have been built in every occupied country of Europe. It remains for the Netherlands to produce a transmitter built under the noses of the Gestapo.

According to a report issued last month by the Netherlands Information Bureau, work was begun a year ago by three Dutch experts so that the new radio station "Herrijzend Nederland" (Resurgent Netherlands) would be ready to go on the air as soon as the Allies reached Dutch territory, and would not lose any time in starting its broadcasts. The orders were for a transmitter powerful enough to be heard all over Holland. To have started such a big job in one place would have inevitably led to discovery by the ever-watchful German police. So the transmitter was built in sections, hidden at widely scattered points. Everything had to be carried out in the greatest secrecy, particularly the meetings of the men and the transportation of the various parts, as the Gestapo liked to ask questions of anyone who visited certain houses too frequently. Construction of the secret transmitter was marked by more than one narrow escape.

The Netherlands government in London was kept informed of the plan by secret messages and at the end of September, when some parts of Holland had been liberated, the different sections of the powerful transmitter were triumphantly assembled. An aerial was strung "between two chimneys" and the great moment had arrived! Since October 3 "Herrijzend Nederland" has been broadcasting on regular schedule to the people, including those still under the Germans, giving them messages of importance and hope for the future.

"SILVER SPHERES" are replacing the tinfoil "windows" formerly used to confuse ground radar, according to reports from over Germany last month. The "windows" used to consist of thousands of little strips of tinfoil. Released by raiding planes, they fluttered slowly to earth, appearing on the radar screen as hundreds of blobs, and thus often made it impossible to identify and locate the planes.

Used against planes equipped with the electronic "Mickey" which permits bombing through cloud layers and overcast, the guess has been hazarded that these spheres, drifting about in the sky, might interfere with and confuse the attacking planes' radar, making blind bombing inaccurate.

Such a "weapon" might prove of considerable importance, as during the winter our bombers have found overcast, clouds or fog below them in a large number of instances. Difficulties for the defense, in releasing the balloons at the correct time, controlling the height reached under various barometric conditions, reckoning for wind drift, etc., must make them a strictly limited defense weapon.

ELECTRONIC MUSIC received a serious audition at the Moscow (Russia) Conservatory last month, according to a report in *Time*. A battery of six "emeritons," new electronic musical instruments, formed an orchestra to play the works of old masters before a select audience of music enthusiasts.

Technical details on the instrument are sketchy, but it is understood that pitch is controlled by pressing the finger on a cloth-covered fingerboard somewhat like a piano keyboard. A series of filters are controlled by pushbuttons; with these the timbre is varied, so the quality of music can be made to resemble that of the bassoon or fife, with numerous known and unknown instruments between. Volume is controlled by a foot-pedal.

The inventors both combine electronic with musical skill. Alexander Ivanov, one of the co-inventors, was the star performer of the concert. The other, Andrei Rimsky-Korsakov, is a grandson of the famous composer.

"HORROR" programs are being progressively dropped by Canadian stations, Dr. Augustin Frigon, manager of the Canadian Broadcasting Corporation, stated last month. Persuasion is being brought to bear on private stations to discontinue such programs as soon as present contracts have expired, said the CBC official.

This is in line with recommendations of the House of Commons Radio Committee, which expressed the belief that horror programs, certain soap operas and medicine shows were in bad taste and suggested that the CBC eliminate them.

Monthly Review

to the Technician

THOUSAND-LINE television has been developed in France, several newspaper reports stated last month. This flattens earlier reports that French advances in television were "greatly exaggerated" to say the least.

Rene Barthelmy, chief engineer of the Compagnie de Compteurs of Paris, recently staged a party at which a number of international engineers witnessed the new development. One of these was Morrie Pierce, former engineering supervisor of WGAR, WJR and KMPC, now finishing a two-year term as chief engineer for OWI in Africa and Europe.

"The first demonstration was the projection of a 450-line picture onto a small screen approximately 4 x 6 feet," said Mr. Pierce. "Program material was both live and film pickup. Quality was quite good considering the quality of the same picture as viewed on a 12-inch tube.

"A demonstration was held of the 1050-line system as viewed on a cathode ray tube of 15 inches diameter. The picture was extremely good, the definition in contrast being excellent. At a distance of six or seven feet from the cathode ray tube the quality of the picture was quite comparable with that of home movies. The 450-line was somewhat better than a newspaper picture, but distorted by the stroboscopic effects, while the 1050-line picture was not quite as good as a fine-line magazine print. The same type of iconoscope was used on both. All transmissions were by wire. Engineers stated the band width required for the 'high-definition' system was between 12 and 15 mc. . . ."

EDUCATION on the air received a boost with the application last month for 18 FM stations by the Ohio State Department of Education. The Department has plotted the location of the proposed 18 FM educational stations; outlined the programming possibilities of each; surveyed the sites; and outlined proposed transmitter power, antenna gain, tower height and channel assignment.

Ohio has already had considerable experience in educational radio through the State University station WOSU, and is the headquarters of the Institute for Education by Radio.

Cost of the Ohio chain is expected to total \$336,000. The State Legislature is expected to finance regional stations, but local stations will be financed by organized non-profit educational agencies such as Boards of Education.

Organized labor and other groups have also applied for numbers of noncommercial stations to be devoted to cultural and educational activities. Largest of these is the application for six noncommercial stations by the United Automobile, Aircraft and Agricultural Implement workers. According to the application, entertainment will be a secondary feature with these stations, which will feature the arts, economics, political and social sciences.

MASS TELEVISION, used mainly for educational purposes, will be the likely direction of development in Russia and China, according to representatives of those countries who reported at the Television Broadcasters Association conference in New York December 11-12.

Large screens erected in villages and city parks to be viewed by crowds will be the probable first use of the art in the Soviet Union, according to Gregory Irsky, chief engineer of the USSR moving picture industry.

"We have always had a problem in handling crowds at our great pageants and parades," Mr. Irsky pointed out. "For example, when we have the great celebrations honoring Lenin in Red Square, thousands visit Moscow for the spectacle. With television screens erected in the squares of Russian villages, we hope to bring such spectacles, which do much to anneal national unity, to the people."

China's reason for desiring mass television is economic, explained T. Y. Lo, of the China Motion Picture Corporation. The resources of that country are so depleted by eight years of war that television can be introduced only as a mass instrument.

"There will be nine or ten years of rehabilitation in China," he pointed out. "Until that time has passed, and until the national living standards have been improved, the average Chinese could not buy an expensive receiver. Consequently we see television developing first in our country as an educational instrument, with screens placed in the libraries and other places of assembly. It will not, in that stage, carry entertainment as such, but be utilized totally for rehabilitation and education."

NEW SLANT on television costs was brought out by O. B. Hanson of NBC, in a technical question-and-answer forum at the Television Broadcasters Association conference December 12, 1944.

In answer to a question, Mr. Hanson stated that television stations and programs might be expected to cost three or four times as much as radio broadcast stations and programs. The television impact could be estimated as at least ten times as great, particularly from the viewpoint of advertisers to whom television offered opportunities never attainable in sound broadcast. These advertisers would certainly be prepared to buy higher rates for a service which gave them greater returns for their money.

Revenues might therefore be expected to be considerably higher than would appear in estimates based on sound broadcasting rates. This might permit the existence of a larger number of television stations than earlier forecasts (*Radio-Craft*, January, page 205) had suggested as a practical possibility.



DR. E. F. W. ALEXANDERSON last month was awarded the Edison Medal for 1944, "for outstanding inventions and developments in the radio, transportation, marine and power fields." Presentation of the award, which was made by the American Institute of Electrical Engineers, was scheduled for the joint meeting of the AIEE and the Institute of Radio Engineers January 24.

Dr. Alexanderson, now consulting engineer for General Electric at Schenectady, is one of the earliest workers in the radio-telephone field, having built the high-frequency alternator for Professor R. A. Fessenden, which enabled the Fessenden station at Brant Rock, Mass., to transmit the first broadcast in history, on Christmas Eve, 1906. With improvements, this became the famous Alexanderson alternator.

ENGINEERING interest in post-war activities is responsible for doubled registrations at the 1945 Winter Meeting of the Institute of Radio Engineers (January 24-27), according to late pre-meeting reports. Registrations ran well above three thousand, approximately a 100% increase over last year.

The meeting has been extended one day, covering a four-day schedule as compared to the three days of last year. Even with the extension, the large number of original papers to be presented made it necessary to divide them into two technical sessions running simultaneously through Friday and Saturday, January 26 and 27.

LT-COL. KENDALL BANNING, formerly well known in the radio world, died December 27, 1944, at the Fort Howard Veterans' Hospital in Baltimore. His age was 65.

Commissioned as a major in the Signal Corps in 1917, he served also as Director of Pictures, Committee on Public Information. In 1918 and 1919 he was on the Army General Staff in Washington. Later he compiled a pictorial record and history of the war.

Between the years 1922 and 1928 Kendall Banning was the editor of *Popular Radio*, one of the best-known radio magazines of the '20's, leaving the editorial post on *Cosmopolitan* to take the position.

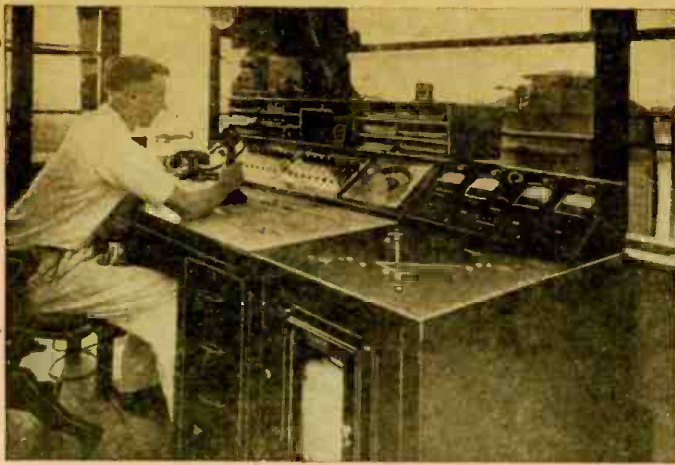

Courtesy American Airlines

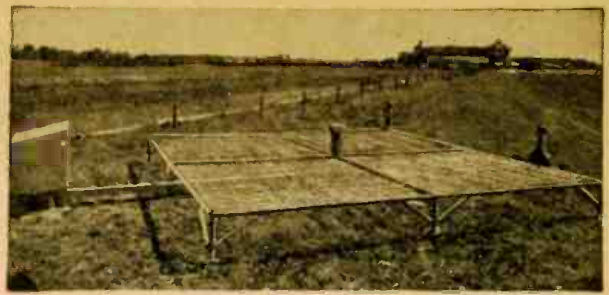

Above—Inner marker instrument landing antenna. Left—Indianapolis landing system control desk.

A PRIMER of AVIATION RADIO

By RAYMOND LEWIS

AVIATION radio is achieving greater prominence in both domestic and international flights. Much has been written and said about the success of our world-wide wartime airlines, but seldom is full credit given to the part radio has played in this achievement. Aviation

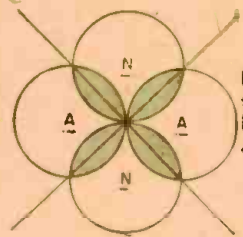

Fig. 1—Symmetrical field intensity distribution in four-course aviation radio range.

radio has become one of the primary considerations in all types of flying, military, commercial, and private.

Necessity for expanded facilities raised the question of frequencies. There are not enough available spots for all the services desirable in the interests of safety and convenience in the air. Even before the war the far sighted CAA made plans for such an eventuality by exploring the use of the very high frequencies (VHF) for aviation radio. Experiments have continued to a point

where as soon as practicable after the war a wholesale program of changing over to the VHF will be initiated. Some airports are already equipped with VHF instrument landing systems and the armed services have made wide use of these frequencies for control towers.

While the average radioman need not understand all the complexities of this specialized field of radio, because of its increasing importance in our daily lives, at least an introduction to the primary aviation radio instruments is desirable. The basic units for a properly equipped aircraft are the transmitter and receiver. They are different from most ground units only in ruggedness of construction, since they must pass rigid specifications set up by the CAA.

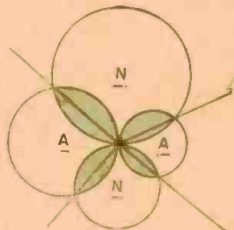

Fig. 2—Field intensity distribution for producing non-reciprocal course alignment.

These units operate from a variety of primary power sources ranging from dry cells to 110 volts AC. There is little standardization outside of physical dimensions. Aeronautical Radio, Inc., a non-profit radio company formed by the major airlines, was set up to eliminate a great deal of work which was at cross purposes in this field. Not all airlines use the standards set up by this organization, however.

The weight factor is the major design consideration in all airborne apparatus, since any excess weight subtracts from the effective payload of the carrier. Therefore aircraft transmitters and receivers are designed for a minimum of weight. Transmitters are crystal switching and band-switching, except for some military services where this would be impractical. Receivers vary from simple single dial tuning with only a volume control to one unit incorporating a special range band, manual and automatic direction finders, A and H homing switches, and complete communications coverage down to 25,000 Kc.

It is in the change-over to the very high frequencies (VHF) that the radioman is first likely to meet equipment foreign to him. Receivers and transmitters are held to the same general requirements as medium

or low frequency aircraft units, but performance and application looks vastly different.

The majority of existing radio ranges operate in the frequency range 200 to 400 Kc. They are received by the communications receiver or a special-range band receiver. The low-frequency simultaneous radio range field intensity patterns are familiar to most radiomen in some variation of the form shown in Fig. 1 and Fig. 2. The standard five tower Adcock range consists of two pairs of crossed Adcock antennae together with a central vertical tower for the transmission of carrier energy and speech. By transmitting the two figure of eight patterns alternately and keying one with the Morse character A (· —) and the other with the character N (— ·) in such a manner that these signals interlock, it is possible to make a direct aural comparison of the received intensities of the two signals. When flying in the range the pilot follows the course defined by the steady dash or "on-course" line passing through one of the intersections of the field patterns. Flying to the left or right will permit either the A or N to predominate and indicate in which direction the deviation from the on-course is. At frequent intervals the station identification is transmitted as well as weather conditions. The central tower is used for this purpose and provides a signal of uniform intensity in all quadrants of the range.

Without going into the theory of the low frequency range it is enough to say that a number of difficulties are encountered in

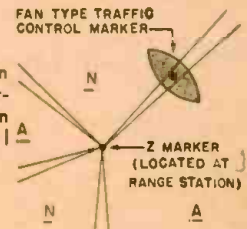
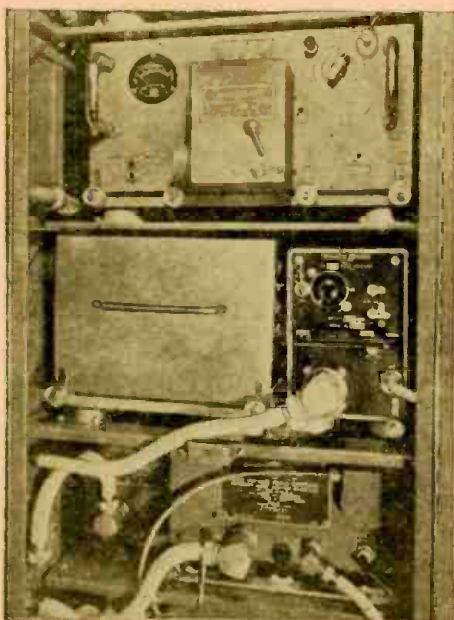

Fig. 3—Vertical fan and Z markers operate colored lamps on the pilot's control board.

this type range which can be eliminated or greatly reduced by the use of VHF. Course instability, interference between widely separated stations, and multiple courses—especially in mountainous countries—are the principal faults found on the low frequency range band.

The very-high-frequency system of radio ranges operating from 119 to 126 megacycles has made possible many improvements (Continued on page 313)



Airliner high-frequency transmitter-receiver, marker-beacon receiver and direction finder.

COVER FEATURE:

RADIO PILOT LANDS PLANES

By S. R. WINTERS

SIMILAR to the function of a "Seeing Eye" dog in leading a blind person through perilous city traffic, a novel radio blind landing system for airplanes contacts the pilot 75 miles from the airport and, at an 8,000-foot altitude, slices a radio path through overcast to within a few feet of the end of the runway.

This new method of landing planes blindly in the weather hazard of low-hanging clouds is not to be confused with the radio beam or radio range system of guiding aircraft by the equality or inequality of the signal intensity of certain dots and dashes as they are spurted out by a radio transmitter. "On the beam," a phrase that has caught the popular fancy, means that an airplane figuratively rides a slender radio beam with unerring accuracy from one point to another. But a plane, like everything else that goes up, must come down—this radio blind landing system brings a flying machine down safely to rest on its runway.

Developed jointly by the National Bureau of Standards and the Army Aircraft Radio Laboratory at Wright Field, Lieutenant-Colonel F. L. Moseley describes it as the "new instrument approach system." The localizer radio transmitter, similar to the transmitter used in defining a radio path or track for guiding aircraft along the airways, differs in two particulars from the radio-range system. It indicates the line of flight for landing to the pilot visually (rather than by ear through a radio headset) on the airplane instrument board. Furthermore, the

Positions of vertical cross-bar indicator refer to position of plane nearest meter.

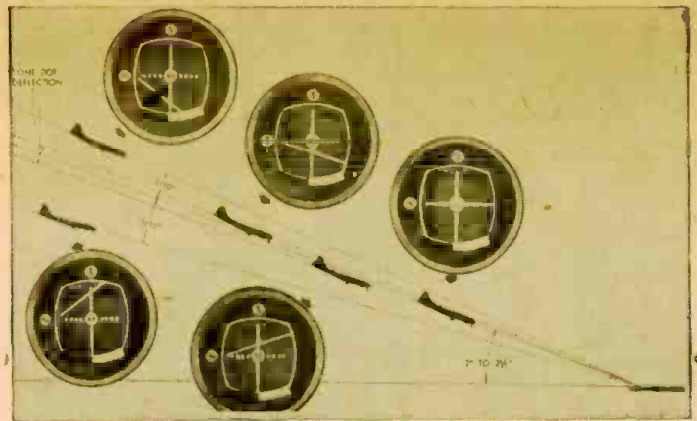

transmitter functions in the band of extremely high radio frequencies—beyond the realm of static disturbances common to the broadcast band and even higher frequencies.

The trial-and-error method of determining the worthiness of this system preceded its adoption and standardization. Its public demonstration was as recent as two years ago, at the Pittsburgh airport—following a slow evolution of the various instruments and technique comprising the system. Now, after 4,000 hours of satisfactory functioning its "coming out party" has been a pronounced success (at the Bryan, Texas, airport). The U. S. Army Air Forces labels this instrument landing of airplanes "strictly a radio show."

THREE ELEMENTS IN SYSTEM

Somebody has described a radio receiver as a well-integrated apparatus of many small parts working together harmoniously. Similarly, this aircraft instrument landing system consists of several important components; when working as a unit designed to penetrate low-hanging clouds by informing the pilot when he is lined up with a cloud-screened runway, the distance from the airport, and the precisely measured rate of glide that will bring the plane within a few feet of the runway.

The localizer transmitter, with its towering steel mast, when mounted on a truck, resembles equipment for steeple-chase climbing more than a portable radio transmitter. It is placed 1,000 feet from the upwind end of the airplane runway, and the truck with the radio equipment can be moved readily, subject to the vagaries of wind and weather. This localizer transmitter spurts out the two tone-modulated radio patterns, which intersect as a line in space, thus affording the pilot a center-line to the middle of the runway—with the airplane in flight as far distant as 75 miles, at an altitude of 8,000 feet.

On the instrument board of the airplane is a cross-pointer meter, which tells the position of the flying machine with respect to the localizer line—whether to the left or to the right. One side of the instrument is yellow, the other blue. All the while regardless of heading, the localizer transmitter indicates the color of the sector in which the aircraft is navigating. The needle of the localizer, however, points unerringly toward the course line when the plane is approaching the runway from the true direction.

Inasmuch as the localizer transmitter is a special kind of radio beam or range, it must be flown by "bracketing," according to Lieutenant-Colonel Moseley of the Army Aircraft Radio Laboratory. With assistance of the directional gyroscope, heading corrections for deviations of only a few degrees are necessary because of the well-defined sharpness of the localizer course. The indicator needle is as sensitive as the weighing scale at the National Bureau of Standards which weighs a pen-and-ink signature. This indicator needle is sensitive to a fluctuation of 3 degrees from the course line—so much so that the needle will then make a complete swing to its greatest scale range. This extreme sensitivity is necessary to insure correct alignment of the airplane with the center of the runway.

The markers or checker pointers, previously referred to as one of the component parts of this radio system, consist of the following units: three markers, 75-megacycle radio transmitters, placed along the localizer course; one 4½ miles from the airport (flashing two dashes per second), one at one mile from the airfield (flashing six dashes per second); and the boundary marker 200 feet from the end of the runway (throwing out a constant light).

A VERTICAL RADIO BEAM

The glide-path (or corridor) radio transmitter, positioned about 750 feet upwind from the runway's approach end and 400 feet to one side, spurts out an exact radio beam descending at a low angle to the runway. As observed by the pilot, these glide-corridor signals start from the landing point on the runway at an angle of 2½ degrees, and stretch to a distance of 15 or more

(Continued on page 315)

Below—Glide-path transmitter for horizontal needle.

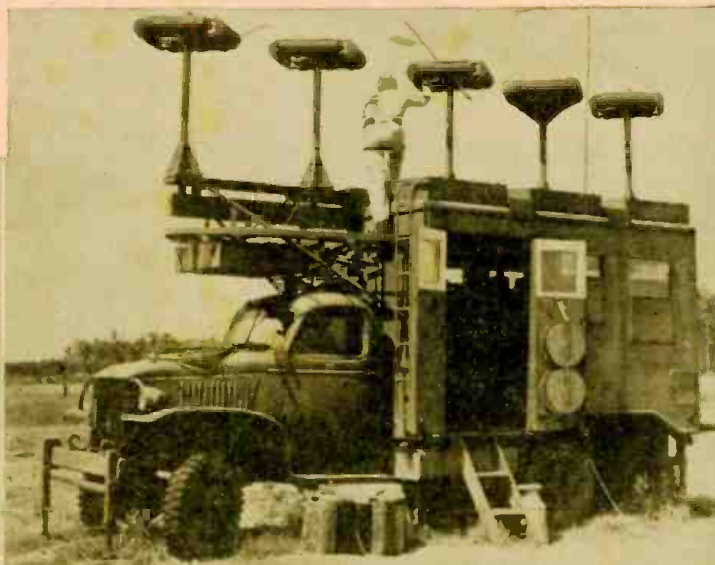

Above—Localizer transmitting unit is stationed 1000 feet from upwind end of runway and operates vertical cross-pointer needle.

Basically, the system is threefold—a localizer radio transmitter for bringing the airplane in line with the runway; a glide-path (a track) radio transmitter for directing the aircraft at the right rate of descent; and markers or check points over which the pilot obtains a radio fix, taking into account the distance of the plane from the end of the runway.

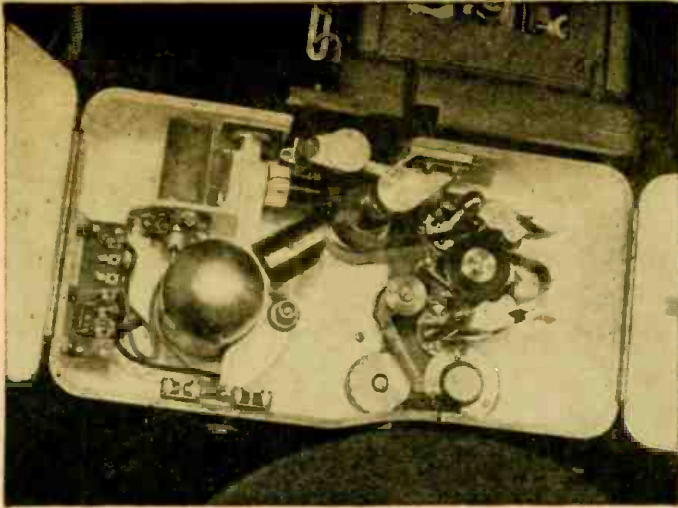

Microphonic reproducer. Lamp and lens-hood may clearly be seen. The photo-cell goes behind film in cylinder at oblique end of lens-hood.

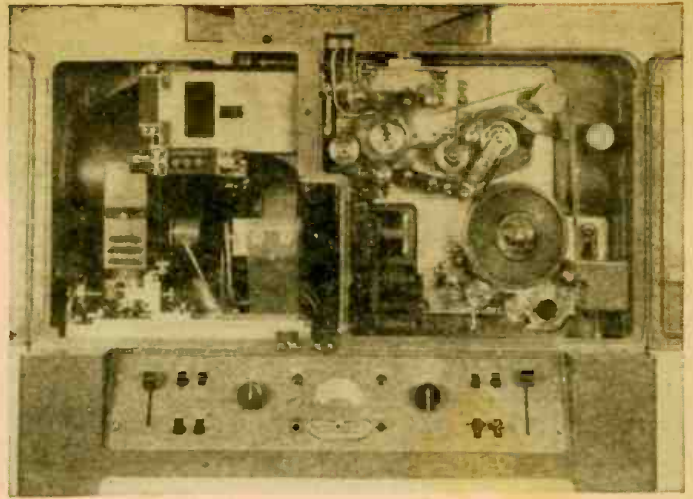

Recorder interior. Left-hand portion contains lamp and light valve. At the right may be seen the mechanical film-propelling apparatus.

Photos Courtesy Electrical Research Products Inc.

NOISELESS RECORDING

By I. QUEEN

BACKGROUND-free recording of film sound, with highest fidelity and widest dynamic range, is possible if one has knowledge of both electronics and photography.

Three principles in sequence, Fig. 1, are; Sound, (a) converted to EMF controls light source (b) to expose film (c) to a series of recorded vibrations of exposure. Film is then processed (Step Two). In playback, (Step Three), (a) constant light source monitors variations of exposure on film (b) passing them so they strike photo-cell (c) which produces EMF (d) which is amplified and then reproduced. Transformations must be linear to avoid distortion.

Film comes in two sizes, "standard" 35mm. (width), and "amateur," 16mm. Large theatre projection uses 35mm., while small theatre and homes use 16 mm. The 35mm. has advantages as follows; for high frequencies the light variations will be very closely spaced along the film if the latter moves slowly. Since the larger film has a linear speed of 1½ ft./sec. (2½ times as fast as the 16mm. film) it will obviously have a better response. Also, because of the greater width, more light may pass through the track and less amplification is required. Finally, scratches and dust on the track intro-

duce correspondingly less noise on the 35mm.

Fidelity in reproduction requires that the constant light be modulated by the film exactly in accordance with the original sound. For this, a very thin slit (as wide as the track) is placed in front of the film. The total amount of passed light must vary with the instantaneous sound pressure of the original acoustic energy. This equals the product of average transparency of film by the slit area.

Two general methods may be used to modulate the light. Firstly, Fig. 2, to decrease it by 50% we may either maintain the transparency of the film, decreasing by 50% the slit area, or, as in Fig. 3, we may allow light to pass through the entire slit area and decrease by 50% the transparency.

VARIABLE AREA SYSTEM

This method uses a vibrating galvanometer suspended in a strong magnetic field, a tiny mirror reflecting the constant light source onto the film in accordance with the A.F. (See Fig. 4.) For original adjustment only half the aperture area is illuminated. Modulation alternately increases and decreases the exposed area so that maximum

corresponds to variation from zero to full. Theoretically, the smaller the height of the slit the better the fidelity. In practice the height is less than .001 inch. Film recorders use optical systems which focus down the mechanical slit to obtain this small opening. By resonating the entire galvanometer system to a very high audio frequency we get a constant response throughout the audio range. These recorders are very rugged, require little adjustment, and have good fidelity.

VARIABLE DENSITY

Recording of this type is done by two methods. Formerly the output current of an amplifier had a quartz glow lamp to provide variable light. The tube, responding almost instantaneously to EMF variations, exposed the moving film. Only the linear portion of the lamp characteristic may be used. Outmoded because of limited output and delicate construction, this method is still the ideal for amateur work.

Outstanding fidelity and stability are obtained by the light-valve recorder, Fig. 5. Two duraluminum ribbons are positioned in a magnetic field. A.F. currents passing

(Continued on page 320)

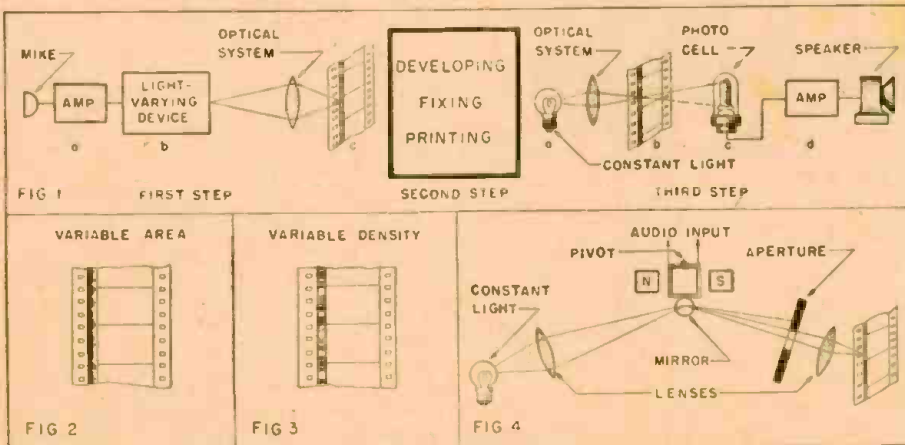
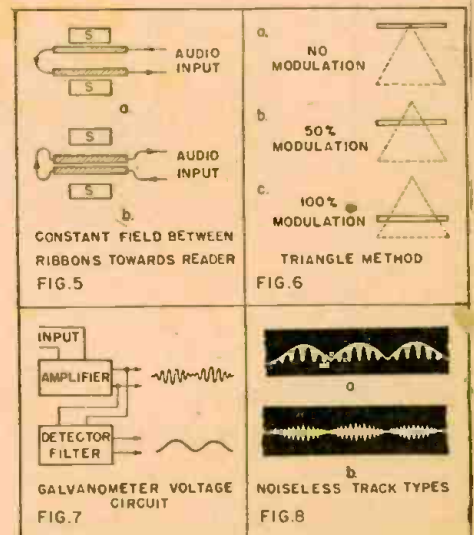

Fig. 1—The three steps of reproducing movie sound. Fig. 2, 3—Variable-area and variable-density film. Fig. 4—One recording system using an oscillating-galvanometer-modulator.



CAPACITY BRIDGES

How resistance- and capacity-measuring circuits work, and how to construct three practical checkers, are described in this article

By ALFRED THOMSON*

AT ONE time or another the experimenter, amateur or serviceman is faced with the problem of measuring an unknown capacitor or resistor or perhaps the measurement of one that may have altered in value.

To enable measurements to be taken with some degree of accuracy, most apparatus for this purpose is constructed around the principle of the Wheatstone Bridge, and all of the bridges described in this article employ those principles.

The Wheatstone Bridge in its simplest form is shown in Fig. 1. It consists of a symmetrical network of six arms, one containing a source of current such as a battery or oscillator, another a detector, which may be a pair of phones or a galvanometer. When the impedances of R1, R2, R3, R4 are in proportion, no current flows through the detector arm because points A and C are at the same potential. This condition is realized when $R1 \times R3$, which is the same as $R1 \times$

$$\frac{R2}{R4}$$

$R4 = R2 \times R3$. From the above it will be seen that if three of these resistances are known, the remaining one can be calculated.

In Fig 1 the resistor R4 is the unknown, but if we make R3 variable as in Fig. 2, then by altering this resistor (R3), a point may be reached where the detector will show no reading, as points A and C will be at the same potential. This is known as the null-point method. It can be readily seen that by employing R3 as a standard against which to check the unknown (R4), a large range of values may be measured. Let us suppose that R4, the unknown, is higher than the maximum value of the standard R3. If R2 is made 10 times R1, then R4 at balance is 10 times R3. This point illustrates a very useful quality of the bridge method, that of extending the range of comparison beyond that of the standard.

A PRACTICAL BRIDGE UNIT

Fig. 3 shows a simple practical type of Wheatstone Bridge, which may be employed for the measurement of resistance from 10 to 100,000 ohms, and of capacities down to 100 mmf., with a reasonable degree of accuracy. The bridge is energized by a Neon lamp connected as a relaxation oscillator. The A.F. transformer is an ordinary broadcast-receiver type with a ratio of 3/1 or 5/1. The condenser C1, value .005 mfd, is connected across the neon lamp and determines the frequency of oscillation. This value may be altered to produce a suitable

*Assoc. Brit. I.R.E.

note in the phones by substituting various values of C1. A high resistance R1, of 0.5 meg., is connected in series with the transformer and neon to limit the current passed. The D.C. voltage supply is determined by the neon lamp employed. One operating around 100 volts is suitable.

R2 and C2 are the standards of resistance and capacity respectively. They should have close tolerances, preferably 1% or 2%. Variable resistor R3 is of the wire-wound potentiometer type with a value of 10,000 ohms, "linear taper."

HOW TO OPERATE THE BRIDGE

- (1) Connect to D.C. supply.
- (2) Connect a pair of headphones to the terminals provided.
- (3) Connect the resistor or condenser to be tested across terminals C and R.
- (4) Set the switch to the C or R standard.
- (5) Rotate the potentiometer knob until the audio note provided by the relaxation oscillator is no longer heard in the phones or is at a minimum. The scale of the potentiometer is calibrated, this being done by placing known values of resistors and condensers across the C and R terminals. A reversing switch may be incorporated to reverse the bridge action, then calibration on the resistance range will hold good for capacity also. As the current drain is very small it is suitable to use "B" batteries as a D.C. source.

A small self-contained portable bridge is shown in Fig. 4. This unit may be built into a box measuring 7 by 5 by 4½ inches. The range of measurement is from 100 ohms to 10 megohms and from 10 mmf. to 10 microfarads. The tube oscillates at a low frequency to energize the bridge, and a pair of telephones are employed as a balance indicator. "B" voltage of only 6 to 9 is re-

quired. This can be supplied from a "C" bias battery. The tube can be almost any battery type triode. The method of operation is similar to the previous one. This potentiometer is also of the linear wire wound type, so that its resistance is proportional to length of element. It should be calibrated against known values of resistance and capacity. The resistors R1, R2, and capacitors C1, C2, C3, should again be of close tolerance as they are the standards. This unit may also be used as an A.F. oscillator for providing signals when testing the A.F. stages of receivers and amplifiers.

The third bridge—shown in Fig. 5—utilizes the 6E5 magic eye tube as the balance indicator, so doing away with headphones and enabling greater accuracy to be obtained, as well as a greater range of measurement. This bridge will measure resistances from 10 ohms to 10 megohms and capacities from 10 mmf. to 10 mfd. It incorporates a leakage test using a Neon lamp and also has provision for measurement of power factor. When constructed with close tolerances it is a most versatile instrument, and should help fill the need of servicemen for a reliable and portable instrument.

EASILY BUILT AND CALIBRATED

The instrument is A.C. operated and completely self-contained. There is nothing difficult in its construction and it is quite easily calibrated against known values. If possible a resistance box should be used for the calibration. This will ensure a greater degree of accuracy. When an unknown resistance or capacity is connected across the C and R terminals and the range set to the appropriate position, the potentiometer is turned until maximum shadow is indicated on the 6E5. The value of the unknown element is then read on the calibration scale. When testing condensers, if balance is difficult to obtain, probably the condenser has a large loss.

(Continued on page 304)

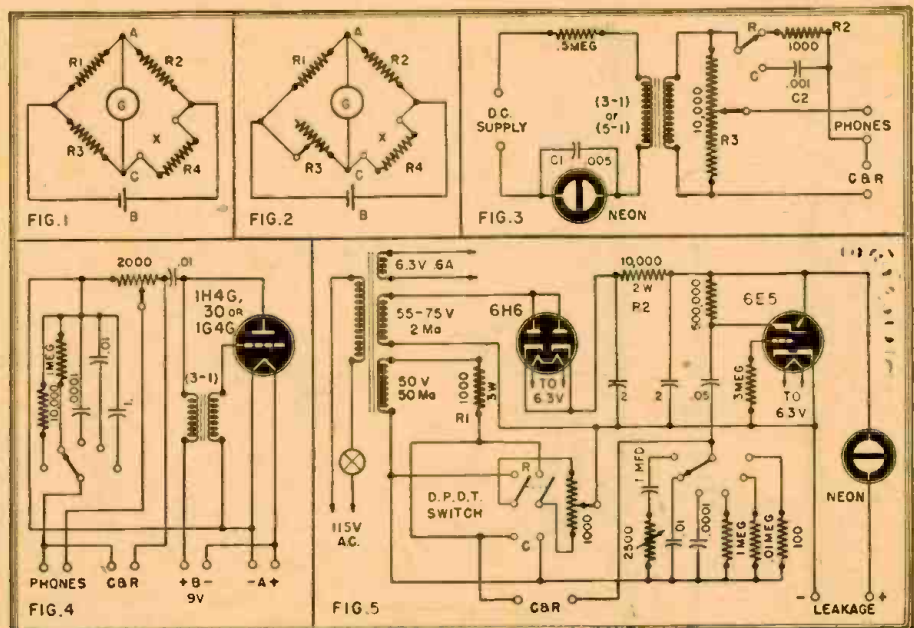

Fig. 1—The basic Wheatstone Bridge circuit. Fig. 2—A practical adaption, with one variable arm. Fig. 3—A D.C.-operated capacity checker. Fig. 4—A tube oscillator circuit. Fig. 5—Ray-tube resistance-capacity meter.

Super Photo-Timer

Revolutionizes X-Ray Photofluorographic Technique

AN all-electronic photo-timing device enables X-ray technicians to make photofluorographs automatically with the absolute assurance that each exposure will be perfect. This development permits substitution of cheap photofluorographs (photographs of the light image formed by X-rays on a fluorescent screen) for the large and expensive X-ray photographs on 14- by 17-inch film. A new field in public health service may thereby be opened up (*Radio-Craft*, December, 1944).

The principle was first utilized by Dr. Russel E. Morgan under the direction of Dr. Paul C. Hodges, Director of Radiology (X-ray technique) at the University of Chicago, and is currently being commercialized by Westinghouse. Fig. 1 shows the rough details of its action. It is a standard X-ray fluoroscopic apparatus, with the addition of electronic equipment in the lower part of the photofluorographic hood.

X-rays from the tube pass through the object to be examined and are turned into light upon striking the screen. Thus an image varying in density according to the opacity of the object to X-rays is formed. This image is photographed in the ordinary way by the camera. Meanwhile the lens focusses part of the light on the screen onto a phototube. As light reaches the tube, its infinitely high resistance drops, permitting more or less current to flow from the battery, according to the amount of light reaching it. It will be seen that the tube is in the grid circuit of a thyatron used as a trigger tube. As current flows through the phototube, the condenser is charged and the grid voltage rises. At a certain voltage, the tube fires and the relay is opened, stopping the exposure. The size of the condenser controls the time required to charge to the firing point for given quantity of light.

AN AUTOMATIC METHOD

Exposure timing, which formerly was an involved process for each exposure, becomes fully automatic once a preliminary adjust-

ment is made by means of a control on the timer. This permits making denser or thinner negatives according to the technician's preference or the conditions under which work is done.

By the old individual-exposure method the time of exposure or voltage applied to the X-ray tube were varied. Unexpected voltage variations during the exposure of a negative might affect results, which were in the long run dependent on the technician's judgment. With the electronic control, the current through the X-ray tube is set at some particular value, but variations of current (or voltage) are of no consequence, and the exposure time is allowed to vary over a range from 1/20 to 1/5 of a second. Only a very rough kilovoltage adjustment is made, based on an estimate of subject size, and the thickness of the subject need not be measured. Using the timer, therefore, the procedure involves merely the positioning of the subject, a rough kilovoltage adjustment in accordance with a quick visual classification, and the touching of an exposure switch. The increased operating efficiency is evident in this comparison. Moreover, since the photo-



Mr. C. T. Zavales, Westinghouse X-ray engineer, mounts the phototube camera under hood of a standard photofluorographic unit.

tube is affected only by the light intensity from the scanned section of the screen, uniformly good exposures are insured regardless of the thickness of the object or of irregularities within it. A skilled technician cannot compensate for invisible, unknown internal irregularities, but the photoelectric timer can, since it is only affected by the light intensity on the fluorescent screen.

DETAILS OF THE CAMERA

The essential parts of the phototube camera are the focusing lens, the photoelectric multiplier tube, a condenser, a re-

Fig. 1 — Graphic explanation of the electronic photo-timer's operation. "Object" is the body of a subject being examined. Fig. 2, below — Diagram of the entire unit.

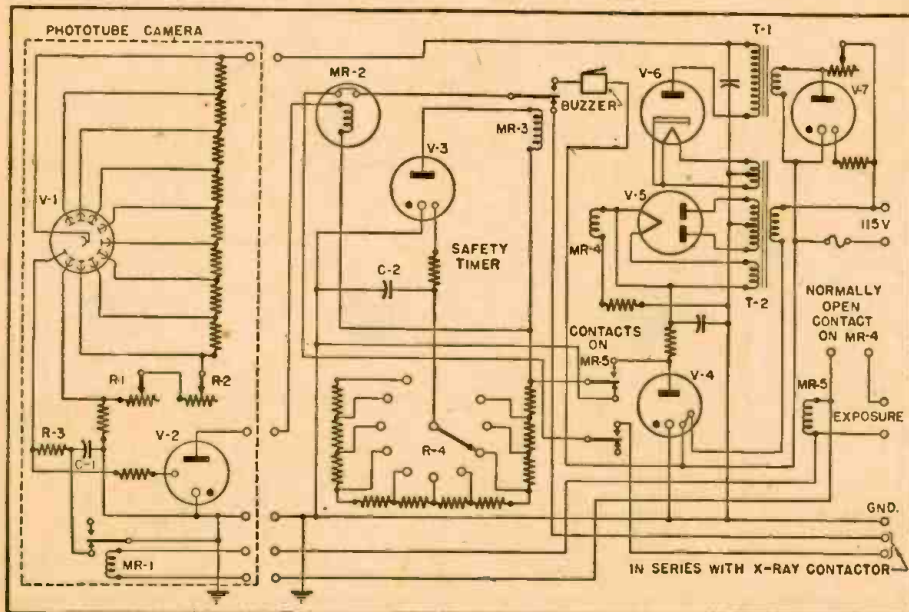
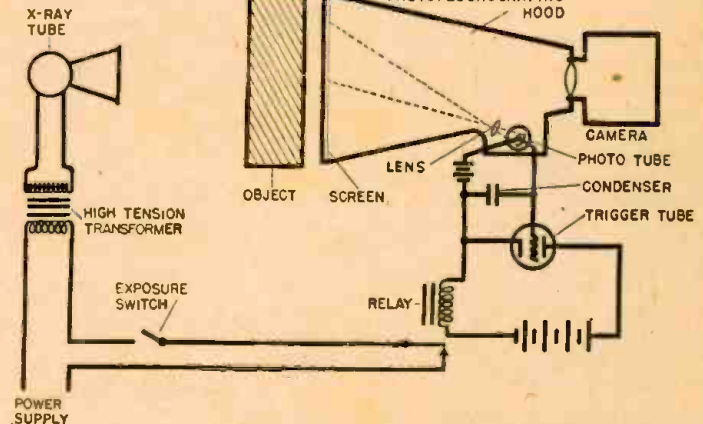

sistance, and a gas triode trigger tube. (Fig. 2, left side) The phototube assembly is mounted beneath the photofluorographic hood, and the lens scans a representative, rectangular area of the fluorescent screen. In chest photofluorography this area, 9½ inches in the horizontal direction and 3¾ inches in the vertical, coincides with the portions of the upper lobes of the right and left lungs because they are representative areas of the subject's chest.

The multiplier tube has nine stages of amplification, providing a 400,000 to 2,000,000 gain. From 800 to 1000 volts between cathode and ground are furnished by the power supply unit. There is 150 to 200 volts from anode to ground. These ranges are provided to compensate for variations in tube sensitivities. Power is supplied to the timer by two transformers. One transformer furnishes regulated voltage to the photoelectric tube; the other serves the remaining circuit tubes. The main X-ray control switch turns on the timer power as well as the X-ray tube filament supply.

The density of the exposed film can be adjusted in accordance with the preference of the radiologist. A density control mounted

(Continued on page 326)

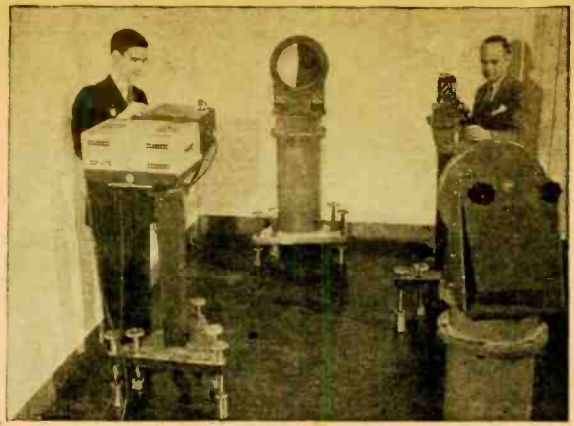
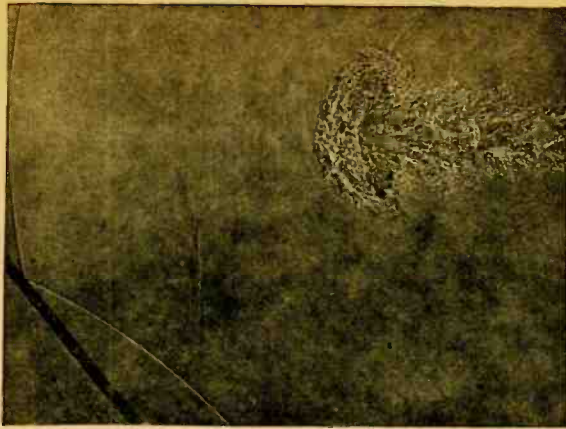

Left—Photograph of a sound, produced by a gun explosion off right. Reflected wave is seen. Right—Photograph of the schlieren apparatus.

PHOTOGRAPHING THE AIR

PHOTOGRAPHIC technique so sensitive that it can take a picture of a flow of air—such as the wind around a corner—is now an accomplished fact. So sensitive is the new apparatus that it could take a picture of a ghost—should one get in front of the camera—say its inventors.

This amazing process, recorded by means of a flashlight with an exposure of less than one-millionth of a second, photographs things which are invisible, such as the finest details of air disturbance, even to the extent of making an image of a heat wave rising from the palm of one's hand.

According to the inventors of the method, Norman F. Barnes and S. Lawrence Bellinger, engineers of the General Electric Company's laboratories at Schenectady, there are two general methods of making air flow visible. The first involves introduction of material particles, such as those of smoke or dust, into the air flow being studied. Light is directed upon the flow, and reflection thus makes it visible.

The second method is based upon the change produced in optical properties of air when its temperature or pressure is changed. We are all familiar with the fact that such materials as glass and water can refract or bend light which passes through them. For example, if one sticks a pencil in water, holding it half-way in and at an angle, the pencil will appear to be bent at the water surface because of the bending of the light by the water. If different parts of an air mass have different optical densities, they bend light passing through them.

Since a change in its pressure or in the temperature of air produces a change in the light-bending power, it is possible to make that change visible by building an optical system which is very sensitive to such bending or refraction of light rays.

Based upon this requirement two types of equipment have been designed and built—the schlieren apparatus and the shadowgraph apparatus. The schlieren apparatus—in which we are interested—consists essentially of a light source, two concave mirrors, a knife edge or razor blade, and a projection lens and viewing screen. The light source used is a General Electric Mazda Type BH-6 lamp. This lamp is a high-pressure mercury lamp operating at 1,000 watts and is smaller than an ordinary

cigarette in size. (See *Radio-Craft*, November, 1943.)

The two concave mirrors used are similar to astronomical telescope type mirrors of finest quality. They have a focal length of 8 feet and a diameter of 1 foot.

The knife-edge assembly consists, basically, of a thin, opaque object having a sharp, smooth edge, a razor blade, for instance.

The projection lens is an ordinary high quality lens used to focus the air flow pattern upon the viewing screen. This lens and the viewing screen can be replaced by an ordinary camera if it is desired to photographically record the air flow picture.

In operation the mercury lamp forms a light source which is so small that it may be considered as being effectively a point source of light. The light from this lamp expands out in the form of a cone of light and falls upon one of the large concave mirrors. If the lamp is placed at the correct distance from the mirror, that is, at its focal point, the light reflected by the curved mirror will be changed from an expanding cone of light to a parallel or cylindrical beam of light. This parallel beam of light is then allowed to fall upon the second concave mirror. This mirror in turn then changes the parallel beam of light into a converging or contracting beam of light so that the light is squeezed, so to speak, down to a tiny spot of light in a manner just the reverse of the way it started out.

The knife-edge is then placed in the system at the point where the converging cone of light reaches its smallest diameter. This edge is then adjusted in height so that it just cuts off all the light in the converging cone and does not allow any of the light to pass by over the top of the knife-edge. Hence, no light passes on to the projection lens and therefore no light can be focused upon the viewing screen.

The region of parallel light between the two concave mirrors is the region in which the air flow phenomena will be studied. The way the system is now set up, every ray of light passing along this parallel beam will be caught by the knife-edge.

If, now, some heated air or air under high pressure is introduced into this region, this air will bend the light rays passing through it. Bending is produced because this air has different optical properties from

the surrounding air, as we have seen before. The rays which are thus bent are no longer part of the parallel beam of light and hence will not be converged by the second mirror to the same point as before. In this case, then, some of the rays will be bent upward so that they will "hop over" the knife-edge. The projection lens can then focus them upon the screen, and a picture of the hot or high pressure air will be seen. Consequently, for every point in the air being investigated which produces a similar bending of the rays, there will be a corresponding point on the viewing screen which is illuminated with light. The composite of all these illuminated points will produce the picture we see. The accompanying photograph gives an idea of some of the startling effects which may be produced. In this schlieren picture a boom was produced by a gun muzzle, off the picture at the right, the sound wave being directed against a metal plate, at left. As it bounced off the metal plate, the path the sound wave traveled was clearly recorded. At right is a mass of hot air that was expelled from the gun muzzle after the blast occurred, while, behind the metal plate at left, is shown part of the wave that slipped around the target and left a curving imprint of its own. In thus making visible the invisible this amazing camera process promises to make a major contribution to research where the flow of gas is being studied.

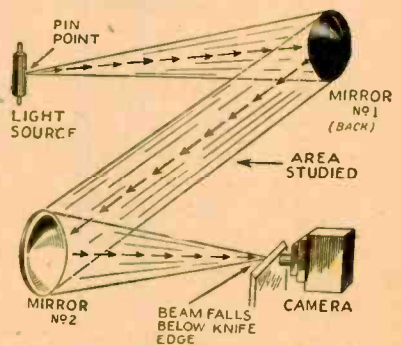

Path of light-beam from lamp to camera in the apparatus in photograph above (right).

ULTRA RADIO

This one-tube features phosphorescent panel marks and other post-war details

By BOB WHITE

THE short wave enthusiast who wants dependable reception on bands between 10 and 120 meters will find this receiver ideal. The 117P7-GT tube, which combines a half-wave rectifier and beam power amplifier, is employed as a self-powered superregenerative detector. The superregeneration makes possible around-the-world reception with only a 15-inch antenna. Although the entire receiver with the case measures only 5 x 5½ x 3½ inches, many features are included in the design—such as plug-in coils, tapped coil range-extender, band spread, stand-by "B" switch, and luminous dials.

CONSTRUCTION DETAILS

In the original model the panel was constructed from a masonite board measuring 5 inches across, 4½ inches tall, and ¼ of an inch thick. No shielding for hand capacity

the panel fastened to the chassis, which measures 4½ inches wide, 3½ inches long, and 1 inch tall.

After the parts that are fastened directly to the chassis or panel are firmly in place, the filter condenser (C1-C2) may be mounted. If not small enough to fit under the chassis, it may be fastened to the side of the potentiometer. (See the picture.) The 1000 ohm wire-wound resistor is mounted on a tie point terminal to prevent short circuiting to the chassis.

The wiring is very simple, but care should be exercised in not omitting any connections. The pilot lamp is optional. If it is used, it should be suited for 120 volt operation, and should be connected across the 117P7-GT tube's terminals 2 and 7. The plug-in coil data shown in Fig. 2 is only approximate, and minor adjustments will be necessary. It is better to have too many turns of wire to begin with, than not enough. All the plug-in coils are wound on 4-prong tube bases.

The broad tuning of the superregenerative receiver is helpful in picking up distant stations, but it tends to make the tuning range for one coil very short on the lower frequencies. It was noted that the opposite was true of the oscillating range. The lower frequencies will allow the detector to oscillate over a longer range without adjustment of the plate coil. Then, it was reasoned, if in some way grid turns could be added or subtracted at will, the range would be extended over a much longer band.

As a result a tapped coil was placed in series with the plug-in coil's grid circuit. (See Fig. 1.) This coil was wound with No. 24 S.C.C. wire on a ⅞-inch form 1¼ inches

long. It is tapped at the 2nd, 3rd, 12th, 17th and 23rd (last) turn. When selector switch S3 is connected to contact 0, coil CL1 is entirely shorted and reception at the high frequencies is possible with plug-in coils A, B, and C. But starting with plug-in coil D the range can be extended by switching in a few turns of wire to increase the inductance.

After the receiver has been wired and tested the case can be constructed. It consists of two sides and a top and bottom made of sturdy cardboard. Masonite or plastic might also be used. The sides measure 4½ inches tall and 3¾ inches wide. The top and bottom measure 5¼ inches long and 3¾ inches wide.

The picture shows the places that are illuminated in the dark by a phosphorescent chemical. This chemical is known as calcium sulphide and is purchased in the form of paper coated on one side with this substance. The needed markers and letters are traced lightly on the coated side with care so as not to rub off any of the chemical nor waste

(Continued on page 316)

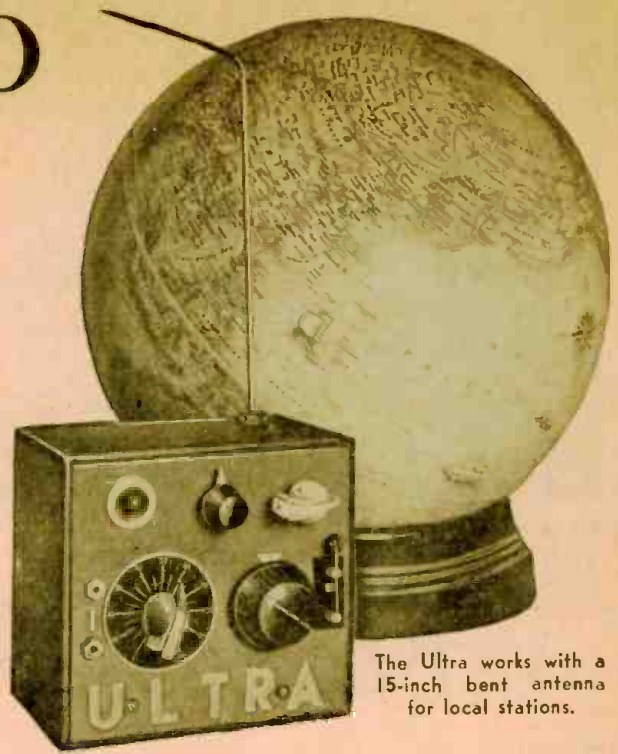

The Ultra works with a 15-inch bent antenna for local stations.

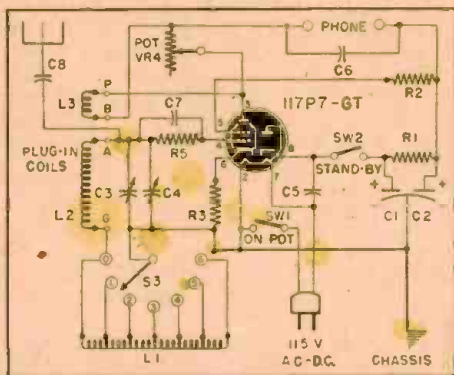
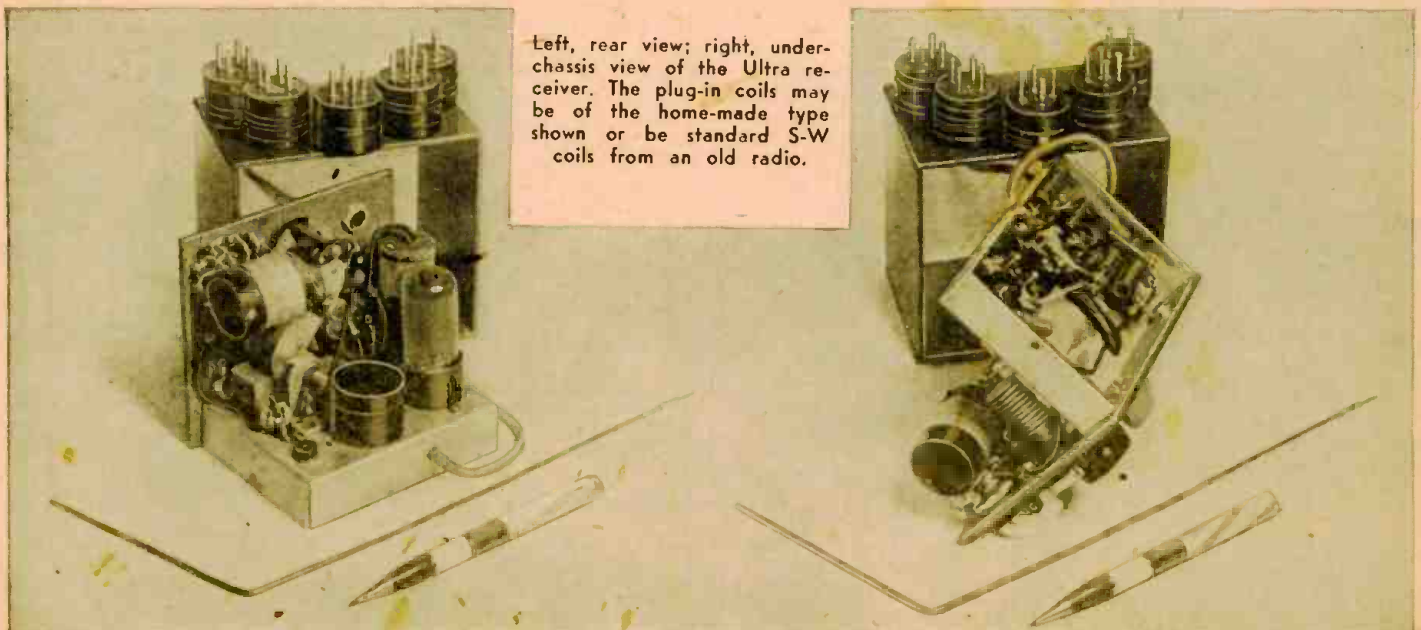

Fig. 1—The Ultra 1-tube all-wave receiver.

is necessary, for the receiver is very stable. After the holes are marked and drilled, the front side may be given one or two coats of colored brushing-lacquer. After this is dry, the main parts may be mounted and



Left, rear view; right, under-chassis view of the Ultra receiver. The plug-in coils may be of the home-made type shown or be standard S-W coils from an old radio.

New FM Receiving System

Locked-In Frequency-Dividing Circuit Reduces Interference

FREQUENCY modulation is the most important advance in entertainment radio since the advent of broadcasting.

Still confined to a relatively small number of transmitters and receivers, FM technique is far from being a fixed art, and it should not be surprising if apparatus and methods now deemed essential should be paralleled or superseded in coming years. Means may be found for accomplishing or improving the present functions of FM apparatus in entirely new ways, and with entirely different equipment.

A step in this direction has recently been made by G. L. Beers of the Radio Corporation of America, in the development of a frequency-dividing locked-in oscillator frequency-modulation receiver. His circuit uses the well-known tendency of an oscillator to "pull" into synchronism with a signal near its frequency to overcome certain difficulties in obtaining satisfactory adjacent-channel selectivity without complicating the apparatus used. Indeed, the new system renders unnecessary the limiter stage of the older method of reception, while maintaining and even increasing the ability of the receiver to reject amplitude-modulation variations in the received signal.

AN ORIGINAL APPROACH

A block diagram of the system is shown in Fig. 1. It differs from earlier circuits in that it contains, after the I.F. stages, a local oscillator which is frequency-modulated by the received signal. This signal is passed by the frequency-modulated oscillator to a discriminator. The oscillator operates, not at the frequency of the incoming signal, but on one-fifth that frequency, and the discriminator is designed for this reduced range of frequencies.

The local oscillator is designed to "lock in" with the incoming signal and follow exclusively its frequency deviations. A program on the desired channel may therefore be heard in the presence of strong signal voltages on adjacent channels. A substantial improvement in selectivity is thus obtained by electronic means.

The local oscillator's output is constant, applying the same voltage to the discriminator whether the signal be strong or weak, or even when no signal is being received. Thus the limiter stage becomes unnecessary and is omitted.

A considerable amount of gain is provided by the locked-in oscillator stage. This amounts, under weak-signal conditions, to approximately 20. Since this gain is at a lower frequency than that of the I.F. amplifier, it is obtained without objectionable feedback, and the receiver stability is improved.

THE OSCILLATOR CIRCUIT

Heart of the circuit is the locked-in oscillator shown in Fig. 2. The tube used is an A-5581, an experimental type similar to the 6SA7 but with a higher mutual conductance. The 860-Kc. oscillator tuned circuit is connected to the plate of the tube and a feed-back coil (tuned to 1720 Kc.) is connected to the No. 3 grid to maintain oscillations. The signal, at 4300 Kc., is applied to the No. 1 grid.

When no signal is being received the tube functions as a normal oscillator. Circuit values are so chosen that strong harmonics are produced, which are applied to the No. 3 grid through the regenerative coupling.

When a signal at the intermediate frequency (4300 Kc.) is applied to the No. 1 grid, beat notes are set up between it and the fundamental and various harmonics of the oscillator. The fourth and sixth harmonics (3440 and 5160 Kc. respectively) beat with the 4300 Kc. frequency signal to produce a beat note of 860 Kc. As the

Fig. 1—Block diagram of new receiver. Two units differ from the older circuit.

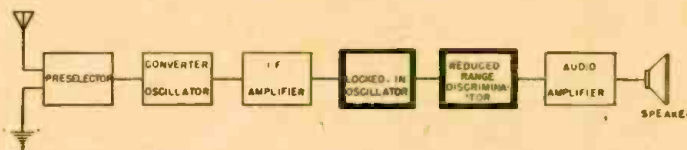

plate circuit is tuned to that frequency, it is passed on to the discriminator. All beats produced by other harmonics are effectively by-passed.

The added 860-Kc. component of the plate current caused by oscillator harmonics beating with the incoming signal is in phase with the 860-Kc. current in the oscillating plate circuit. The circuit becomes stable in this condition and the injected current will "lock in" the incoming 4300-Kc. signal with the 860-Kc. current in the plate circuit. Since the injected current has the same phase and frequency as the normal current, it is merely equivalent to an increased output from the tube.

THE "FOLLOWING" ACTION

Should the incoming signal vary in frequency there will be in effect two currents of slightly different frequencies in the tank circuit. If, for example, the incoming signal increases slightly in frequency, the fourth harmonic of the local oscillator beats with it to produce a frequency greater than 860 Kc. The two currents drift in and out of phase with each other at a rate depending on the difference of frequency between them.

Their combined effect produces an important reaction on the tuned circuit. An instant after the two currents are in phase—selecting that instant as an example—the current due to the incoming signal leads that of the local oscillator somewhat. The tank circuit sees a current with a leading component, which affects it as if additional capacity had been inserted in the circuit. The circuit frequency is therefore decreased.

An instant before the two currents again come into phase the situation is reversed. The component due to the injected signal is now behind the local oscillator component. This lagging component will act as a reduction of capacity in the tank circuit, thereby raising its frequency.

A REACTANCE TUBE

The circuit of Fig. 2 therefore acts like the reactance tube of FM transmitter and AFC circuits, varying its frequency with the lagging and leading plate currents, and swinging the frequency of the circuit back

and forth. If the frequency of the incoming signal is approximately five times that of the tuned circuit, a point will be reached when the frequency of the tuned circuit becomes exactly one-fifth that of the incoming signal. When that happens the oscillator will lock in with the signal.

The sixth harmonic has not so far been mentioned, but it can be shown that the combined result of it and the fourth is a single injected current of variable amplitude and phase. Usually the two harmonics are of unequal amplitude and the effect of the weaker is to produce relatively small variations in the stronger.

By restricting the lock-in range of the oscillator to frequency variations in the desired signal channel a material improvement in selectivity can be obtained. The lock-in range must be wide enough, on the other hand, to follow frequency variations of the received signal and in addition provide for receiver mistuning and frequency drift in transmitter and receiver. This lock-in range depends on a number of factors, including input voltage, I.F. band-pass, tube constants and discriminator impedance. It can be made to have optimum values only by skilled design which takes all these three factors into account.

THE FM DETECTOR

The discriminator circuit used with this system is illustrated in Fig. 3. It is a narrow-band type as compared to conventional discriminators, as the frequency deviations handled by it are only one-fifth those originally picked up by the receiver. Other

Fig. 2, below—The special oscillator circuit. Fig. 3, right—The narrow-band discriminator.

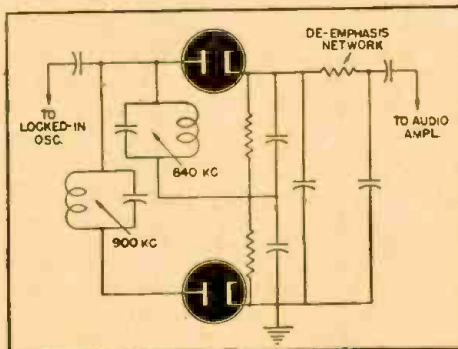
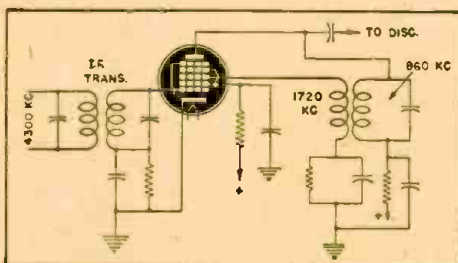

Electronic Thickness Gage

By WESLEY S. ERWIN*

In the highly stressed parts of modern airplanes the complete inspection of section thickness after final machining is important. This inspection becomes a difficult problem on some finished parts where the inner surface of a wall is not accessible. In some cases, an instrument requiring only external contact to the part is necessary.

A supersonic wave can be used to measure the thickness of metal parts by the echo method. However, with thin sections the time intervals involved are extremely short. This is due to the high velocity of sound in metals, for example, about 250,000 inches per second in steel. Therefore, in a

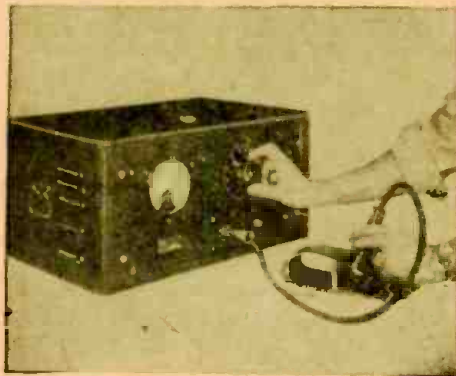

Fig. 1—The Sonigage measuring a metal part.

piece of steel $\frac{1}{8}$ " thick, the echo will return in about one microsecond. Complicated electronic circuits are also involved in these measurements.

An instrument which would be suitable for routine production inspection should be simple to operate and inexpensive to build. These requirements have led to the development of a different supersonic instrument which we have called the "Sonigage."

PRINCIPLE OF OPERATION

The simplicity of the instrument is due to the fact that it does not measure the time intervals directly but rather the frequency at which the work is set into resonant vibration in the thickness direction. Since this resonant frequency in plates of a given metal is directly related to the thickness, the measurement of frequency determines the thickness.

The Sonigage, therefore, consists only of a simple variable-frequency electronic oscillator and a quartz crystal for converting this electrical energy into mechanical vibrations.

Operation of this instrument required only pressing the quartz crystal into contact with the material and tuning the oscillator dial to the resonant frequency of the work as shown in Figure 1. Due to internal damping of the metal, power is required to maintain this resonant thickness vibration. This power is supplied by the oscillator. A power output meter serves to indicate the resonant frequency of the work in much the same way as the electron-ray tube on a radio serves to indicate tuning to resonance with a particular station frequency.

This resonance point is very sharp and if the oscillator is detuned as little as 1%

the indicated power amplitude is greatly reduced. Such sharpness makes accurate thickness measurements readily feasible.

THE CRYSTAL OSCILLATOR

A small flat piece of X-cut quartz crystal is used. Quartz cut in this manner changes thickness when an electrical potential is applied to its faces. The action is reversible and instantaneous, so if a high frequency alternating potential is applied to the quartz plate faces the crystal will change thickness rapidly at that frequency. This forced mechanical vibration can be transmitted to any material by placing one face of the quartz plate in contact with it. Since the amplitude of this high frequency motion is ordinarily only a few billionths of an inch, good coupling such as that provided by an oil film between the crystal and the work is required. Brushing the work with oil before testing is sufficient. A typical crystal and holder are shown in Fig. 2.

The oscillator is a simple one-tube variable-frequency type as shown in Figure 3. Its power output is indicated by a D.C. milliammeter in the plate circuit. By using an efficient coil and good insulation the oscillator power losses are kept low. Normal plate current is therefore small. Variations in this no-load plate current encountered in the oscillator frequency range are

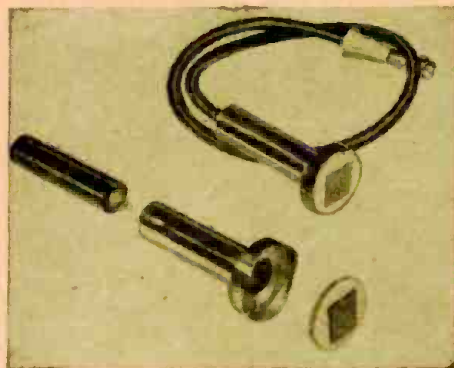

Fig. 2—Two views of the crystal and holder.

compensated by adjusting the special loading plate on the tuning condenser. This small constant plate current is then balanced to zero on the meter by the bridge circuit in which the meter is connected. With this arrangement the meter will read only the additional external power output of the oscillator which is drawn by the crystal when the work is in resonance with the oscillator frequency.

RANGES AND CALIBRATION

A single crystal is sensitive over about a two-to-one range of thicknesses, so oscillators are built to cover a single two-to-one frequency range. Additional ranges would require changing coils, crystals, and dial scales. Because of the low cost and extra inspection capacity of separate units no such multi-range models have been built.

The oscillator tuning condenser dial can be calibrated in frequency but for any one metal it can be calibrated to read thickness directly. This is because the product of the resonant frequency and the thickness will equal one-half the velocity of sound. For any one metal this velocity is a constant

and, therefore, the frequency and thickness are inversely proportional.

For steel the relation is $f \times t = 125,000$ where f is the frequency in kilocycles per second, t is the thickness in thousandths of an inch, and 125,000 is one-half the velocity of sound in steel in inches per second. Fortunately the velocity in steel is not appreciably affected by ordinary alloy content, hardness, or heat treatment, so one calibration holds for all common steels.

Other metals have different sound velocities and would require different calibrations or the use of conversion factors. A few of the common metals and alloys tested on the Sonigage are: Steel, aluminum, brass, copper, silver and stainless steel.

HARMONIC OPERATION

It is also possible to observe harmonics of the fundamental thickness vibration such as the second, third, fourth, etc., with the instrument. The indicated resonant amplitudes of such resonance points will be successively smaller than the fundamental indication and this should identify them as such. In the application to propeller blade measurement the thickness of the parts before fabrication is known and subsequent operations may decrease but not increase this thickness. In this case instruments were designed so the original thickness fell in the thick end of the range. The thickness can, therefore, be measured unless it is about half the original thickness or less, in which case there is no indication and the part is rejected as undersize.

In the more general case where the thickness of the work is not known, the harmonic indications may appear on the dial which correspond to one-half, one-third, one-fourth, or other fractional parts of the actual thickness. For example, in such a case the indication might appear on the dial at .070" and the actual thickness of the sample might be .070" (in which case a large meter indication would be obtained), two times .070" or .140" (weaker indication), three times .070" or .210" (still weaker), etc. The thickness in this case cannot be less than .070" or in between .070", .140", .210", etc. When two or more of such a series of thicknesses are possible, the actual thickness still can be determined by the Sonigage alone. Two adjacent harmonic dial readings R_1 and R_2 are taken. Since these will be $1/n$ and $1/n + 1$ of the

total thickness t , then $R_1 = \frac{t}{n}$ and

$R_2 = \frac{t}{n + 1}$. The solution of these two equations yields $t = \frac{R_1 R_2}{R_1 - R_2}$, or the product of two adjacent readings divided by their difference is the actual thickness.

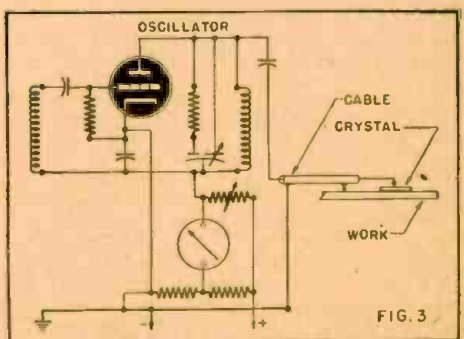
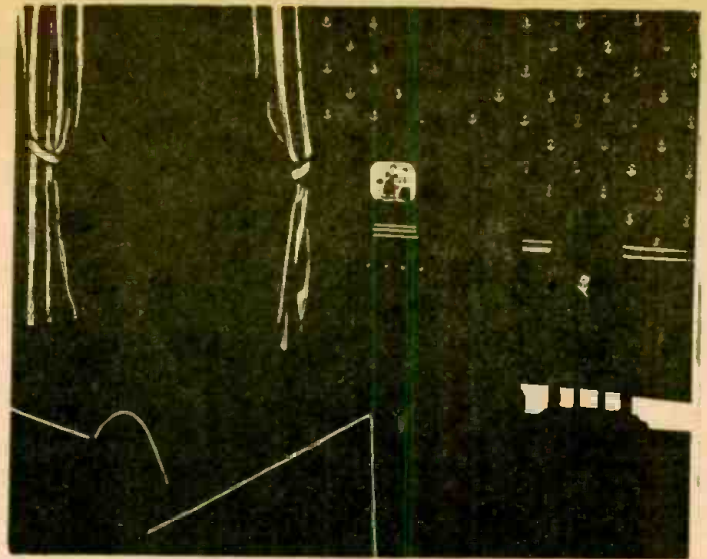
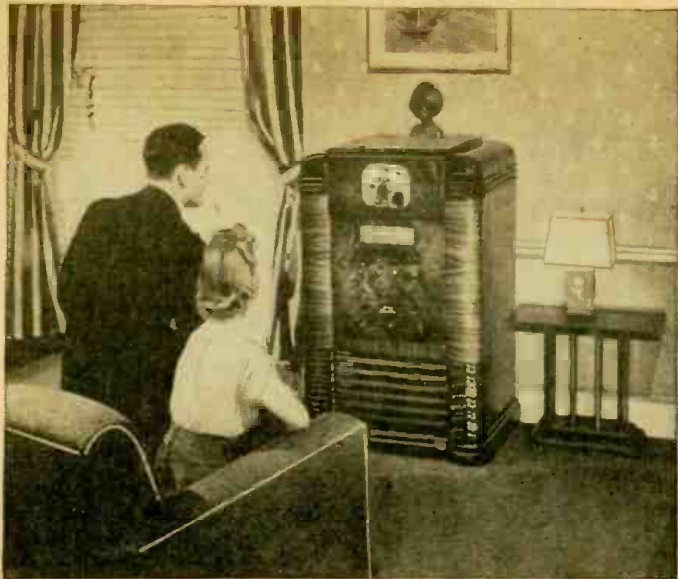

Fig. 3—Circuit of the Sonigage oscillator.

*Research Laboratories Division, General Motors Corporation.



Non-interference with television combined with safety by use of phosphorescent pigments on baseboard, furniture, wallpaper and drapes.

LUMINESCENT RADIOS

By M. A. HEIKKILA*

MOST radio engineers are familiar with the phenomenon of luminescence, particularly that produced by luminescent powders in cathode tubes and on television screens (also possibly the cold light created by phosphors in the modern fluorescent tubes). Probably not as familiar are those specially manufactured luminescent pigments which are excited to luminescence by the absorption of some form of radiant energy.

The latter form of luminescence has been utilized extensively in a variety of war applications such as luminescent dials, navigational instruments and charts, radar equipment, maps, tables and directional signs and markers. It is possible that these luminescent pigments may find wide application in luminescent dials and trade-name plates on radio and television sets of the future, as well as indirectly in the decorative scheme of the home television reception room.

In theory, this form of luminescence is the result of the absorption of a quantum

*Market Development Division, the New Jersey Zinc Company.

of photons within the molecular structure of luminescent pigments, each quantum of energy raising an electron to an upper level, from which it returns—either immediately or after an interval of time—to its equilibrium state, simultaneously releasing the transmuted energy in the form of visible light.

There are two types of luminescent pigments: (1) *fluorescent*, the type which luminesces or glows only during the time of exposure to an exciting light source, and (2) *phosphorescent*, the type that continues to glow for some period, from a few seconds to 10 or 12 hours or more, after the exciting light is extinguished. Fluorescent pigments, therefore, have no useful afterglow, and are distinguished from phosphorescent pigments which, in addition to fluorescing, have useful afterglow properties. (Radioactive materials, which are self-excited, are not included in this discussion as they are basically different materials.)

Fluorescent pigments require light sources

that contain very little or no visible energy if the fluorescent light is to show to best advantage. An ultraviolet or so-called "black" light source, which radiates most of its energy in the longer wave length ultraviolet range from 3200 to 4200 Angstrom units, is suitable for use with this type of pigment. Such ultraviolet light sources include argon glow lamps, tungsten-filament lamps (operated at high filament temperatures), regular fluorescent lamps, high-pressure mercury-arc (vapor) lamps, and special "360 BL" fluorescent lamps. To eliminate all traces of visible light, suitable ultraviolet filters are used, including Wood's glass, pot blue glass and certain plastic compositions.

The "360 BL" fluorescent lamp is the unit developed for, and used extensively in, the war effort and is the light source that probably is of greatest interest to the radio engineer and designer for the excitation of fluorescent dials or decorative effects. This lamp is available in 6-inch, 4-watt and 8-inch, 6-watt sizes. (This special lamp is also available in the longer 15, 30 and 40-

(Continued on page 312)

Another luminescence-treated room, in which the aesthetic effect is intensified by the broad-striped and "blue-heaven" wallpaper.

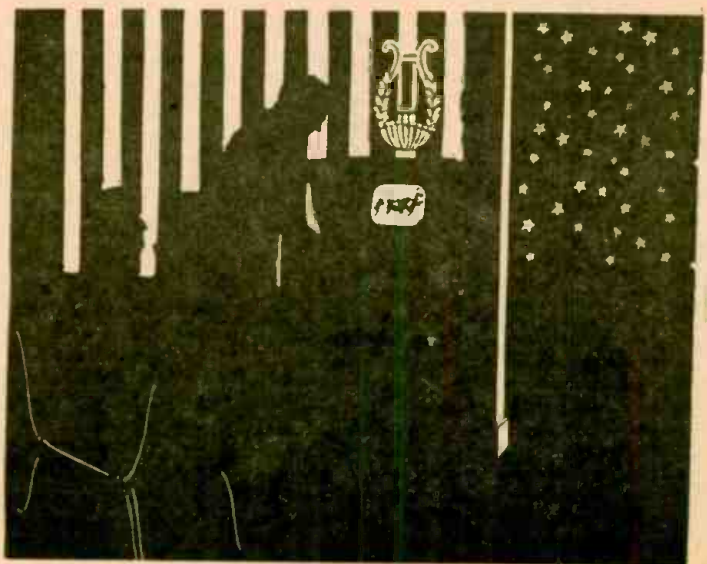

Capacity Phono Pickup

By BENJAMIN F. MIESSNER

IN 1919 the writer recorded but never published what is perhaps the earliest F.M. radio system. A condenser type of microphone was connected across the grid circuit inductance of a feed-back oscillator so that variations of its capacity, caused by impinging sound waves, would produce corresponding capacity variations for frequency-modulating the oscillator.

For reception, a conventional radio receiver was used, tuned not to resonance, but to a point about two-thirds up the resonance curve where it was past linear, either on one side of the curve or the other. Tuned in at one of these two points—say the low-frequency side—an increase of transmitter frequency would cause an increase of received current, while a decrease of transmitter frequency would cause a decrease of received current. The frequency-modulated received current would be demodulated and translated, in the detector circuit, into audio frequency currents corresponding to the original sound waves at the transmitter microphone.

Some years ago the writer applied this principle to the development of a phonograph pickup in which capacity variations between a vibrating phonograph needle and an adjacent pickup electrode were utilized to modulate the frequency of a low-power oscillator. A regular, complete F.M. receiver was used to pick up the modulated signals. The oscillator output could be coupled directly into the R.F. input of such a receiver, and shielded to prevent external radiation; or—if desired—the oscillator could be allowed to radiate through short distances to a receiver in the same room or elsewhere. The principle is also applicable to F.M. transmitters employing R.F. amplification to build up the power for radiation.

THE CONVENTIONAL SYSTEM

In conventional phonograph pickups such as magnetic, crystal, electro-dynamic, etc., the needle is used merely as a connecting link between the record groove and the vibration translating device. In these there are usually masses and compliances which must be driven by the needle and record groove. Work is expended in this driving action and considerable pressure on the needle—of the order of three to five or six ounces—is required for satisfactory tracking and driving operation.

Furthermore, these masses and compliances introduce one or more free periods of oscillation in this vibrating system in the audio frequency range. These resonances cause peaks and depressions in the pickup frequency characteristic with corresponding unevenness in the reproduction of various frequencies.

These devices are velocity-operated generators. This means that at low frequencies the amplitude of the reproduced current is far too low, especially because low frequencies cannot be recorded at full volume due to limitations of the record itself. All phonograph records have the low frequency components compressed; i.e., reduced in volume, due to the necessity of using a low-pitch record groove spiral in order to secure normal playing time for the record. The recording amplitude is therefore limited by the available space between adjacent grooves on the record, through which the recording cutter must not pass.

For these several reasons, a pickup in which the needle constitutes the entire vibrating system, is the ideal type. Such a system is used in this F.M. pickup.

The needle is $\frac{3}{4}$ inch long, the length normally used in recording, and it thus travels through an arc of the same radius as the recording stylus. This keeps the

An FM phonograph pickup which employed a coil was described in *Radio-Craft* a few years ago. Mr. Miessner, who holds many patents in electronic music and other radio devices, here describes a capacity-operated FM phonograph pickup.

needle tip always in contact with the record groove.

The needle's top end is also ground to a fine point and rests in a conical socket at the upper end of the pickup head. The bottom end of the needle is maintained in its normal position by a rubber or other resilient disc attached to the bottom of the pickup head. The needle is thus free to move in any horizontal direction against the weak but sufficient restoring force of the rubber disc. Within a few thousandths of an inch from the lower side of the needle, but within the pickup head case, is an adjustable pickup electrode. The needle is seen at 1 in Fig. 2; the surface of the record being represented by 2. The pickup electrode is at 3. The top end of the needle rests in block 4. A wire 5 leads from the insulated pickup electrode back into the tone arm, and 6 is the screw by which the pickup spacing is adjusted.

Either the needle or the pickup electrode may be grounded to the pickup head case and tone arm, depending on the mechanical design. The ungrounded element is connected, through a central conductor in the tone arm, to the input grid circuit of an acorn tube oscillator, in parallel with the grid circuit tuning inductance. This conductor should preferably be a length of cotton-wrapped shield wire with the shield removed to reduce weight. It should fit tightly in the tone arm tube to prevent movement or vibration of the central conductor, which would introduce undesired frequency modulations of the oscillator. A trimmer condenser of low capacity may be included for adjustment of the mean frequency of the oscillator. A circuit is shown in Fig. 3.

The oscillator tube and components of its circuit may be incorporated in the tone arm stand or in the tone arm itself. A resonant transmission line may also be used between the tone arm and the oscillator tube, mounted, in this case, on the chassis of the F.M. receiver used for its reception. This is suggested by my associate, Mr. Richard Beauchamp.

This arrangement constitutes the truly ideal type of phonograph pickup. The needle, locked at its upper end in its socket and at its lower end in the record groove, can have no free resonance period in the audio

range. Its mass is extremely low, and the compliance of the rubber disc is also low. The undulating record groove, therefore has a minimum of work to do in vibrating it. Consequently, the needle pressure can be reduced to about $\frac{1}{2}$ ounce with resulting low wear on record and needle as well as very low needle scratch. Since the pickup operates by change of spacing (rather than by velocity) of the needle from its pickup electrode, operation is just as good at one cycle as it is at 10,000 cycles per second. Its frequency-response curve is therefore *absolutely flat*. The needle scratch is hardly audible and no scratch filter is used.

Another important feature of this pickup is automatic volume expansion, which is provided in the pickup itself, not by electronic means in the amplifier as is the case with conventional record players.

The pickup electrode is not parallel to the record groove at the point of needle contact, but inclined to it at an angle of about 30 degrees, as shown in Fig. 4. For large undulations of the record groove, the needle is dragged, by the frictional resistance, closer to the pickup electrode so that its lateral vibrations are translated into capacity and frequency modulations with higher efficiency. Thus, the greater the recorded tone amplitude, the greater the efficiency.

This type of pickup may be used also for amplitude modulation of an R.F. carrier in which case it is used as a variable capacitance impedance working as a tuning element in an R.F. circuit. It may also be used as a D.C. polarized pickup, like a conventional condenser microphone, in an A.F. amplifier circuit. In this case it requires a high-voltage charge on the ungrounded element, supplied through a resistor of high ohmic value, to limit the ability of the charge to change rapidly, as is also the case with the condenser microphone.

The writer's patents cover the pickup itself as well as these various types of circuit.

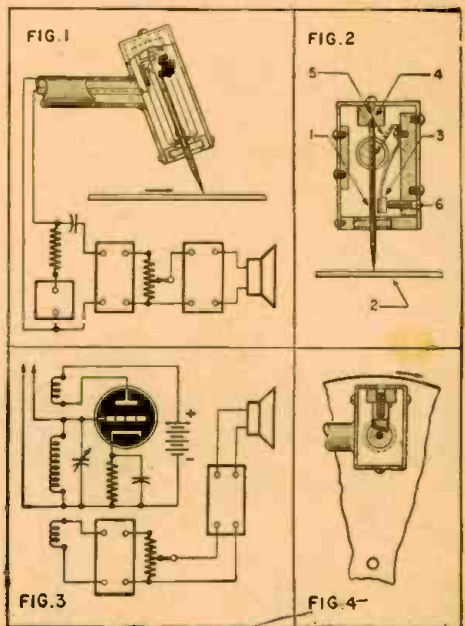
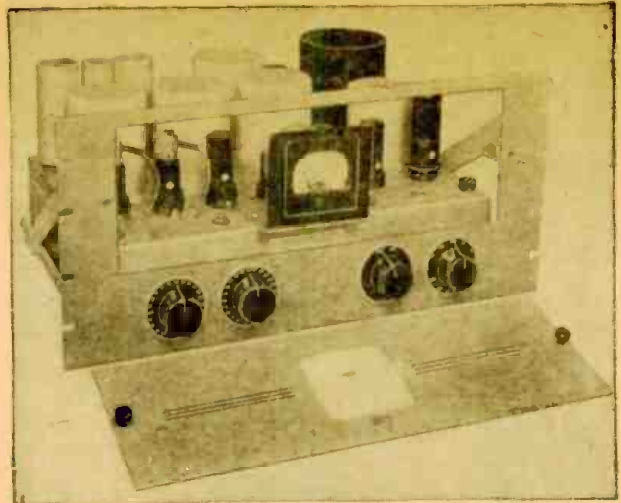

Fig. 1—Pickup, charging source, pre-amplifier and power amplifier. Fig. 2—Details of the pickup. Fig. 3—Schematic of oscillator and coupling means. Fig. 4—Automatic volume expansion is provided by the electrode shape.

BROADCAST EQUIPMENT

PART VI—TRANSMITTING-STATION EQUIPMENT

By DON C. HOEFLER*



EVER since the inception of radiotelephone broadcasting, on that evening in 1907 when Dr. Lee DeForest demonstrated his great achievement before several guests atop New York's old Parker Building, a problem of ever-increasing consequence has been that of adapting the widely varying range of the program material to the fixed volume range of the amplitude-modulated transmitter. The volume range of the transmitter lies between that point corresponding to the innate noise level of the equipment and that level which corresponds to maximum (100%) modulation. This range is usually about 30 or 40 db, while the dynamic range of the program may be as great as 60 db or even more. Furthermore, the coverage of the transmitter is partially dependent upon its average degree of modulation. Volume compression and the technique of "riding gain" are therefore necessary adjuncts to the modern standard broadcast system.

The monitoring engineers at the control booth, master control room, and transmitter must compress the volume range by inserting loss during the exceedingly loud sections and removing loss during the passages at and below the inherent noise level. When this operation is accomplished efficiently, the modulation level is never low enough to harm satisfactory reception nor high enough to cause distortion. Despite the fact that the program level is monitored and controlled at several different points, this process remains very delicate and rather unreliable, requiring of the operator

*Broadcast Engineer, ex WJLB-WLOU, Detroit, Mich.

keen perception, physical coordination, and familiarity with musical compositions. It is further complicated by the fact that the higher the average degree of modulation is maintained, the oftener the peaks will override the maximum of 100%, causing distortion in the transmitted carrier with resultant distortion in the receiver. Since these overmodulation peaks occur with great rapidity, it is practically impossible for the monitoring engineer to compensate for them properly unless he knows beforehand exactly when they will occur. (The subject of modulation will be discussed in some detail in a future installment.)

It was with these inherent difficulties in mind that manufacturers developed the limiting amplifier. This is an amplifier so designed that its output cannot be increased beyond a predetermined maximum value. This desirable function permits the monitoring engineers to relax their diligence with assurance that the transmitter cannot be badly overmodulated, with the result that the average degree of modulation is raised and the station's coverage is thereby improved. Representative types of this equipment are the Western Electric 110-A and the R.C.A. 96-A, now succeeded by the 86-A. The former is shown in Fig. 1 and the latter in the photo above.

The gain of this unit is automatically lowered whenever the program peaks become excessively high. The basic principle of operation is similar to that of receiver automatic-volume-control, in that a small portion of the signal input is rectified to provide a bias control voltage to the ampli-

fier input. Thus 6K7s are utilized in the input, exhibiting the variable- μ characteristic which is particularly useful for such operation.

The volume-compression circuit consists of the 6R7 duplex-diode triode, in which the triode amplifies a portion of the signal, which is rectified by the double diode, with the result that a varying D.C. bias voltage is produced across the resistance in series with the fixed bias on the grids of the first stage. As the signal increases, the bias becomes more negative and the gain decreases. This action is like delayed AVC in that it

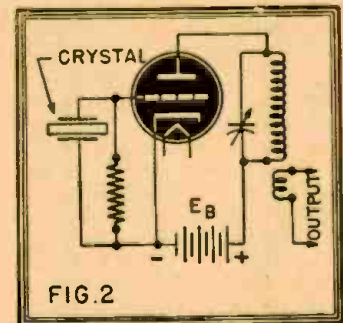

Fig. 2—Standard crystal oscillator circuit.

does not take effect until the audio signal level applied to the limiter tube exceeds its own fixed bias. It should be understood that this operation does not introduce excessive distortion by merely clipping the signal peaks, but rather it actually reduces the overall gain and then permits it to return slowly to normal. It must function quickly in order that sudden peaks may be efficiently compressed. However, much trouble would be experienced if the gain were able to fluctuate due to low-frequency audio notes. The circuit components are therefore so chosen that volume compression becomes effective in 0.001 second, but the gain is not fully restored to normal for about seven seconds. The compressor circuit may be removed by opening switch S1, in which case the unit operates as a straight linear amplifier.

The remainder of the circuit is quite conventional, with the 6N7 twin triode operating push-pull into a resistance-coupling circuit to drive the push-pull output. The 89 power pentodes are triode connected and thus operate class A1. A single meter, in conjunction with suitable shunts and multipliers and a switching arrangement, performs all the measuring functions indicated. With this equipment it remains necessary for the monitoring engineer to increase the gain whenever the signal gets "down in the mud," i.e., when it enters the area comprising the inherent noise level of the equipment.

(Continued on page 310)

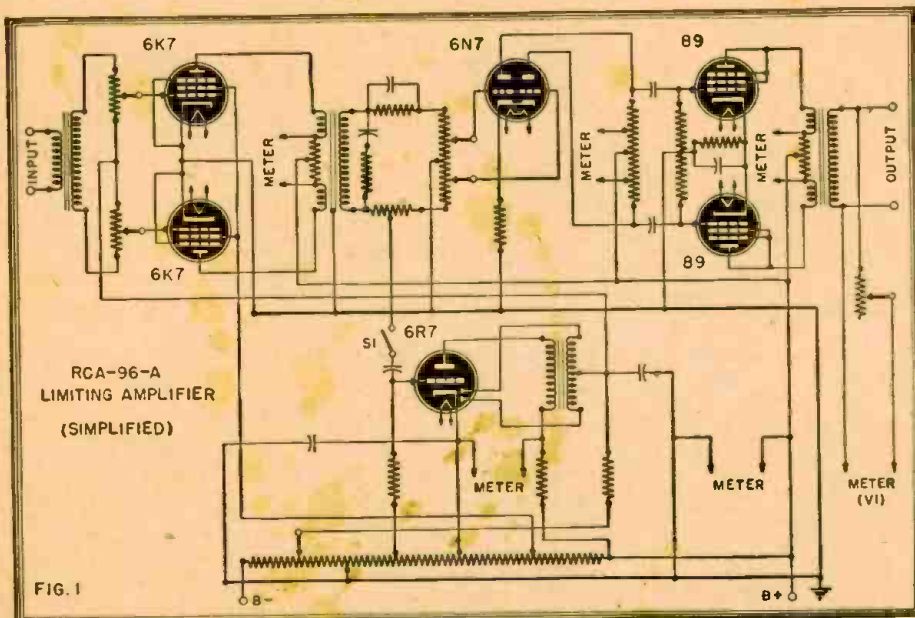

Fig. 1—A typical limiting amplifier, which automatically keeps program level within bounds.

An Electronic Accompanist

By NATHANIEL RHITA

ALL radio experimenters have been fascinated by the pure musical notes obtainable from an audio oscillator. The thought of making up a musical instrument has probably occurred to most of us. Any type of keyboard which can close electrical contacts may be

The lower system of switches will be described at this time. When any single key is depressed the SPST switch involved will close the circuit through the battery B and produce a voltage drop across

enough to operate one of the relays (whichever one is connected to switch SW). When four notes are played as in ordinary quartet music, both relays are thrown regardless of the switch.

Assume now that the organist plays one or more notes in the soprano range. It is at once evident that the oscillator will respond only to that note which corresponds to the highest in its range. For example if he plays D3, D4 and G4, only the latter will sound since it short-circuits the other two. The bass operation is similar (except that the lowest note is sounded).

The alto (and tenor) oscillators respond as follows: Let only one key in the alto oscillator range be pressed. Following the schematic we see that we are merely short-circuiting the tank condenser and no oscillation will take place. For two or more simultaneous notes, however, it will be seen that the second lower note will be sounded, the short-circuit being removed. Similar operation takes place in the tenor oscillator with the second higher note of several being played by it. Therefore, if four keys are depressed at once, and if each falls into the proper range as in normal quartet music, each sound comes from the corresponding loud-speaker. It has already been mentioned that both relays will operate in this case thus opening the contacts at P1 and P2.

For less than four simultaneous notes (which seldom occurs) one or both of the relays will not act, thus shorting two amplifiers and causing one note to be sounded by both. This means that if only one note were sounded in the alto range, only the soprano would oscillate and the note would be heard at both alto and soprano speakers. By determining the position of the switch, the organist operates either of the relays.

(Continued on page 305)

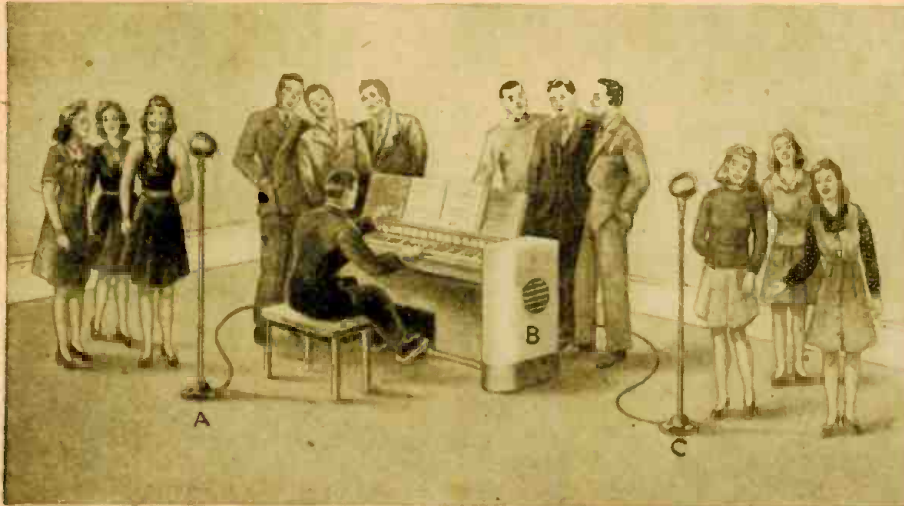

Altos are grouped around speaker A; basses near B; sopranos at C and tenors around the speaker in end of organ opposite B. Therefore each group is helped to sing in its own key.

used and it is an easy matter to build such an instrument where only one note at a time is to be played.

If two keys are simultaneously depressed on such an instrument, evidently only one note will be sounded, since the oscillator can operate at only one frequency at a time. A little thought will show that multi-tone harmony will probably require the use of a separate oscillator for each note on the keyboard. This method is used in the modern electronic musical instruments.

An ingenious and interesting invention by Laurens Hammond of Chicago now makes possible an organ which uses an ordinary keyboard and which sounds up to four simultaneous tones. All quartet scored music may be played with the use of only four oscillators. Each oscillator feeds into its own amplifying and reproducing equipment. Each note of the four is sounded only through the corresponding speaker.

The organ is designed to conform with the generally followed rules of quartet music scoring. In quartet music the four parts in the order of their frequency are: bass, tenor, alto and soprano. The range of each may overlap that of the others, although the extremes are limited to the use of soprano and bass. All four voices are usually sung simultaneously, a single voice seldom resting. The total frequency range seldom exceeds 38 semi-tones (3 octaves plus two semitones from F1 to G4). The letters refer to notes of the scale, the numbers to octaves.

The organ (Fig. 1) is shown to be made up of four similar oscillators, amplifiers and loud-speakers. Each oscillator is tuned by switches which tap off the grid inductance. The small coil is the feed-back inductance. Note that only representative keys are illustrated, dotted lines indicating the omission of all intermediate keys not essential to description. Each key operates a system of ganged switches, each oscillator having either a single or double switch arrangement.

R2 and the two wires, A1 and A2. When more keys are operated simultaneously a greater drop occurs across the wires, which are connected to the two polarized relays P1 and P2.

The instrument is designed so that the relays are not actuated by the playing of one or two keys. However, when three notes are played the voltage will be high

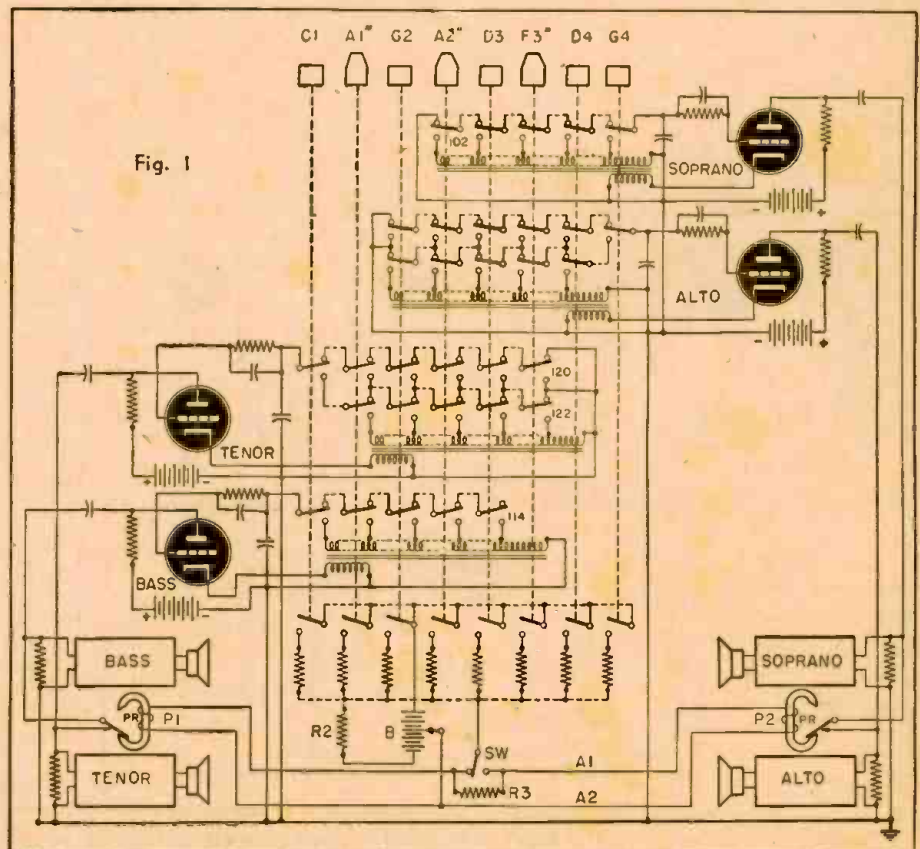

INVERTED TRIODE

A Method of Measuring Small Currents and Voltages

By W. A. HAYES*

BY means of a tube designed specially for the purpose, currents as minute as 10^{-14} ampere (the hundred-thousandth part of a billionth of an ampere) can be measured with an inverted triode circuit.

In this tube the outer electrode, which is normally the plate in an ordinary vacuum tube, is used as the control grid. This inversion minimizes the space charge effect, thereby making it possible to select a value of grid bias that will result in zero grid current. Such sensitivity of measurement makes practical several operations previously considered very difficult or impossible.

This method of construction provides the insulation necessary between electrodes so that practically no energy is absorbed from the source being measured.

The tube may be termed an "Inverted Triode," as the outer electrode, which is normally the plate in an ordinary vacuum tube, is used as the control electrode or grid in this tube. This places the control electrode at a maximum distance from the space-charge region surrounding the filament, minimizing the amount of electrons collected by the control electrode. Thus current to the control electrode is held at a minimum.

The mesh mounted between the filament and the control electrode is used as the anode. This particular construction provides more radiating surface to the grid, thereby decreasing its temperature and possible thermionic emission. The control element or grid, being farthest from the filament, receives less heat and light from it, thus decreasing emission from the grid. (All references to the control electrode or anode of this tube refer to the function of those electrodes in the circuit and not to their physical construction or location.)

The filament is operated at a low temperature to minimize the emission of photo electrons and primary electrons from the grid. All of the electrodes are operated at rather low voltages to reduce the possibility of ionizing residual gas in the tube, which would cause positive ion current in the grid circuit.

It has been found in taking measurements of extremely minute currents that the electrostatic charges which build up on the inside surface of the glass bulb produce a sufficiently high electric field to seriously affect the overall sensitivity of the tube. This electric field also makes consistent results practically impossible. To eliminate this condition a small piece of spring wire resembling a "cat's whisker" is mounted with a slight pressure against the inner wall of the glass bulb. The so-called "cat's whisker" or shield is then brought out to the base pin labeled "shield." This shield terminal is connected to an electrical ground with respect to the other electrodes. If not thus neutralized, electric fields created by the charge on the glass bulb can easily be of sufficient magnitude to exert a greater control over the electron flow than is obtained from the control electrode.

Operation of the instrument is comparatively simple. With the push button (Fig. 1) down, the galvanometer is brought to zero by means of the 25,000-ohm bias resistor and the 1,000-ohm bucking resistor in the anode circuit. The push-button is then released and the unknown voltage applied to the "Input" terminals. This will cause the galvanometer to show a reading. A voltage sufficient to bring the galvanometer back to zero is then applied at the terminals marked "calibrated potentiometer." This is of course exactly equal to the unknown voltage to be measured, and may be read from the calibrated potentiometer.

As low voltages are used on the electrodes, the anode current is low in comparison with ordinary triodes. Therefore, a microammeter or galvanometer must be used in the plate circuit to measure the small currents. The output may also be fed into a suitable voltage amplifier, in which case

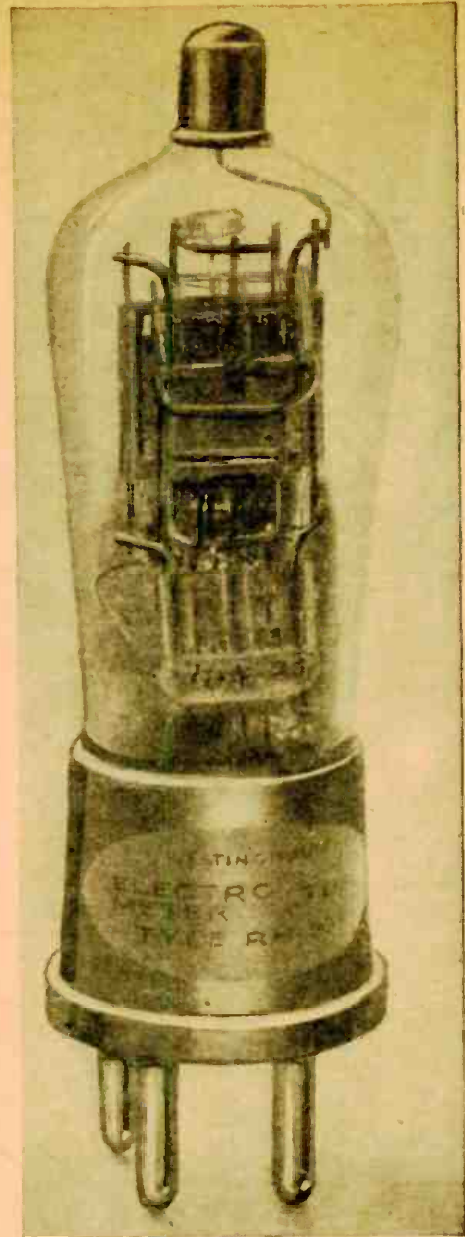

RH-507, the tube used in the inverted triode.

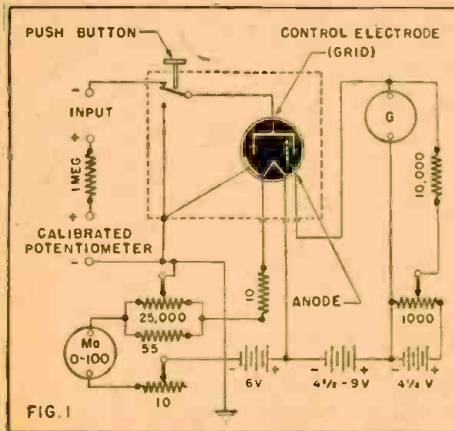

Fig. 1—Schematic of the inverted triode meter.

The sensitivity of this tube is made possible by an extremely low grid current and a high grid-to-cathode resistance. Due to the small magnitude of the currents expected in the type of applications to which the tube is usually put, it is absolutely necessary that none of the minute quantities of current be absorbed in surface leakage. Therefore, every precaution has been taken to design the tube so that unusually high resistance exists between each electrode.

The use of so-called "glass pant leg" supports has provided a maximum surface leakage path between electrodes. The pant leg consists of a glass sleeve surrounding a wire which acts as support for mounting.

*Electronics Engineer, Westinghouse Electric and Mfg. Co., Bloomfield, N. J.

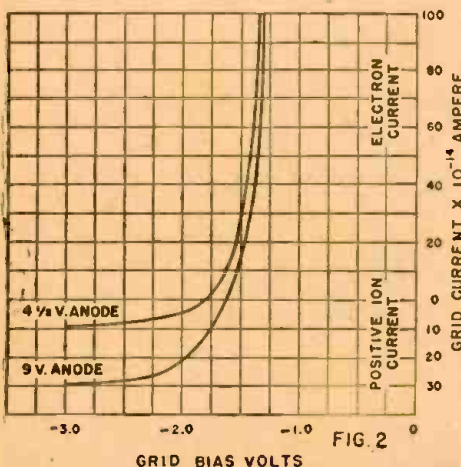

Fig. 2—Control-electrode current vs. voltage.

the RH-507 tube will serve as a coupling device between the source under measurement and the amplifier proper. Should the tube be used in this manner it is possible to use more rugged and cheaper instruments to obtain measurements previously requiring laboratory precision equipment. A typical electrometer circuit using a microammeter or galvanometer is shown in Fig. 1.

The grid current curves represent average values taken on several tubes but the readings on individual tubes may vary considerably from the figures shown. The curve in Fig. 2 with 4.5 volts on the anode shows that the grid current passes through zero at minus 1.8 volts. The important feature to notice is that the grid current of every tube crosses zero at some bias voltage near this value. It is therefore possible to select a value of grid bias such that the grid current is zero; hence extremely minute currents can be measured accurately. By adjusting the grid bias so that the grid current is zero it has been found practical to measure grid currents as low as 10^{-14} amperes to obtain indications of grid currents as low as 10^{-10} amperes. By providing a bias adjustment on either side of the "floating potential," reversal of control current is effected to advantage in electrochemical polarization studies.

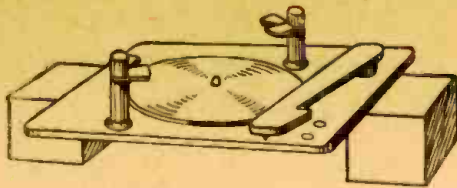

Fig. 1—A simple system for blocking up the record changer on the bench to make repairs.

Record Changers

A Few Notes on Maintenance and Repair

By JOHN NEEDRE

WHAT is the most efficient method of attack on record changers in need of repair? The answer: simply the same logical approach used on electronic circuits. Putting it into general terms:

Visualize the mechanical actions step by step in a manner similar to the way electrical reactions are considered stage by stage in a radio set.

Many faults are so logical as to be perfectly obvious to anyone possessing sufficient curiosity to try a few simple adjustments.

The greatest variety of troubles occur in newly installed machines. It is improbable that brand-new phonographs will be sold for the duration. The statement still applies to machines that have been transported considerable distances and set up in new locations. This appears less of a paradox when the causes are considered in detail. It is easy to see that only a minor misadjustment can interfere with the working of the entire unit. The cause of the breakdown is all too often due to the set-owner's ignorance of proper care and operation of the set. Since prevention is the best cure in this case, some of the more usual causes are discussed first.

1. Improper Unpacking

The unpacking of any radio-phonograph consists of more than merely removing it from the shipping box. During shipment the radio chassis and phonograph unit are both secured by "packing bolts." These are usually painted red for easy identification and when removed leave the radio and phono unit floating freely on rubber or spring mountings.

Symptoms

Jamming of the mechanism in the midst of a repeat cycle or failure to operate at all may be due to binding of the mechanism against the cabinet, caused by packing bolts being tightened down.

If a rim-drive motor spins but the turntable does not revolve, the motor may have a separate packing bolt preventing it from floating on its pivoted mounting. This particular bolt is sometimes never removed but merely loosened enough to free the motor. In this case, it may not have been loosened enough to allow for wearing-in of the moving parts.

2. Improper Packing

The above method of packing would be used by the factory or a service man in preparing a set for shipment, but the customer often ships the set himself. He may fail to safely secure loose parts (probably not even using a box if he intends to carry it in the family car. That physical damage can occur is obvious, but loss of rubber or

spring mountings can make it impossible for the phono unit to rest on an even keel. This may interfere a great deal with the balance of the many small tension springs used to position the levers.

Symptoms

Dropping records two at a time, jamming one side of a record and dropping the other; starting too far in or outside the edge of the record; repeating before the selection is finished; all these faults are typical of a unit that is not level.

Don't forget to check the floor! Older buildings sometimes settle badly and can contribute to faulty operation unless the legs of the set are leveled by placing a block under one corner.

3. Forcing of Mechanism

This is probably the most prolific source of serious trouble. Many people have become familiar with old style hand operated phonographs, and seemingly cannot overcome the habit of reaching for the pickup arm when it is time for another record to start playing. They inadvertently forget that something else is handling the pickup, the sensitive gears and cams of the repeat mechanism located below the motor board.

Levers can be bent and springs broken this way, but it usually occurs that adjustment screws are forced out of position. These are equivalent in importance to the tuning screws in R.F. and I.F. transformers.

Symptoms

Failure of the needle to come down at the proper place on the edge of the record and failure of the repeat cam to disengage, resulting in the repeat action occurring over and over without stopping to play a record is one of the typical faults resulting from such mal-operation. The list of troubles attributable to this cause may exceed the imagination. Care used in placing the blame for the cause of breakdown may help to prevent its recurrence.

If the set owner has developed a habit of operating his set in an improper manner, he may not be aware of the bad effects since they appear gradually. As long as his way

(Continued on page 317)

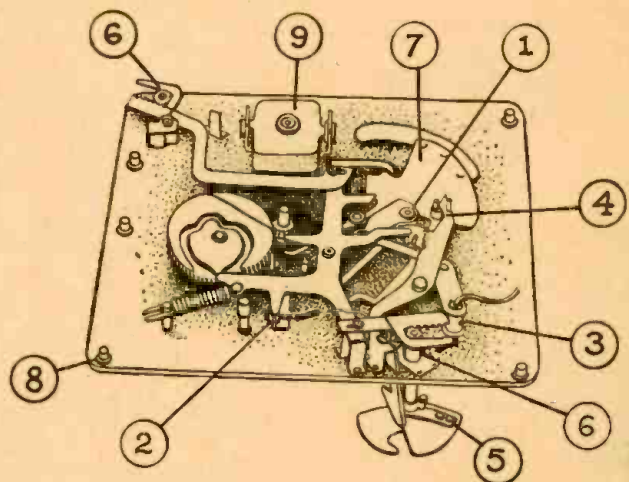

Fig. 3, right—Simplified drawing of the under side of a well-known record changer. Fig. 4, below—A quick-reference trouble chart of the commonest A. R. C. failings.

ADJUSTMENT ON:	SYMPTOM OR TROUBLE
1. Friction Clutch on tripping pawl	Too loose—Repeat mechanism fails to trip. Too tight—Repeats grooves over and over. (using a good record)
2. Height of Pick-up (Turnbuckle)	Needle drags on top record when 10 or 12 records are stacked on turntable.
3. Needle landing place for 10" records. (Set screws on pick up shaft)	Needle misses edge of record or starts too far in on 10" records.
4. Needle landing place for 12" records. (Eccentric stud)	Same as above but for 12" records. This must be set after adjustment for 10" records.
5. Distance between Selector Blades. (Screw and lock nut)	Record selector blades strike the edges of records instead of separating them and sliding in between.
6. Distance of rotation of Selector Blades. (Set screw on Selector Blade shaft)	Records, when released, fall in a lopsided manner instead of both sides simultaneously.
7. Reject Lever (Requires bending or reshaping)	Reject Lever inoperative because of too forceful handling by inexperienced operator.
8. Leveling of player. (Spring retaining screws at each corner)	Needle may fail to slide into starting groove of record if turntable is not level.
9. Oiling. (Use SAE No. 10 oil on motor and petrolatum on other moving parts)	Squeaks that can spoil listening pleasure and "dragging" of motor during operation.

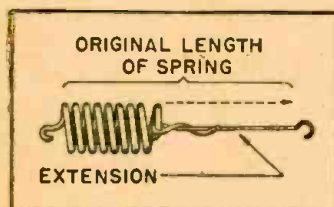

Fig. 2—How to fix a spring by replacing a broken piece.

Earthquake Recorder

DESIGNED for economical long-time operation and including several original ideas, an electronic earthquake recorder has been in continuous operation for the past three years. The instrument was developed by F. Keller of New Kensington, Penn. Constructed chiefly from hand-made apparatus, the electronic seismograph is completely A.C. operated and is capable of magnifying received earth tremors 1500 times before recording them.

The principle of the seismograph may be described as follows: An earth disturbance results in movement of the armature of a seismometer in a magnetic field. An E.M.F. is induced and applied to a galvanometer whose indication is a tiny mirror arranged for rotation. A source of light reflecting from the mirror falls on a photocell and the voltage variations are amplified and recorded.

The seismometer or tremor-sensitive device is shown in Fig. 1. The arm A is supported at the bracket B. The lower pivot P is a jewel cup bearing. The weight W gives the arm a long natural period of vibration (from 10 to 15 seconds). Movement of the arm therefore lags the actual earth tremor while the magnet (M) moves with the earth. As the armature is relatively displaced in the intense magnetic field, its coil (C) generates a corresponding E.M.F. which is applied to a type P, Leeds & Northrup reflecting galvanometer. The source of light is a 6-volt bulb operated at 4 volts for long life. Normally the light reflected passes through a shield so that only half of the available light falls on the photocell. As the mirror vibrates, more or less light falls on it, resulting in an A.C. voltage output.

The various units are installed in a basement to be free from disturbance.

Fig. 2 is the schematic of power supply and amplifier. In order to obtain freedom from voltage fluctuation several regulating methods are used. An automatic voltage regulator provides substantially constant A.C. input. The power supply output is controlled and stabilized by a 6J7 and 2A3 in a commonly used circuit. Constant D.C. voltage is applied to the pho-

tocell and preamplifier by a VR-150.

The preamplifier output passes through a 6SC7 phase inverter to the push-pull 6E6 stage. Note the enormous coupling capacitances. This circuit, in fact, is the great grand-daddy of all low frequency response amplifiers. The long period seismometer used necessitates an amplifier able to pass frequencies of the order of .1 cycle/second.

The output load of the amplifier includes two similar coils wound with 2000 turns of No. 40 D.S.C. suspended in a magnetic field by means of a .025" diameter nichrome wire. A stylus mounted on the rotating assembly follows the variations and indicates on a chart fastened to a large drum. The record is made on smoked paper to save the expense and trouble of photographic paper. The drum shown in the accompanying photo revolves slowly and also has lateral movement so that a spiral record 24 hours in length is made on each chart.

Under normal conditions the currents through the two coils are equal and opposite and no stylus displacement takes place. When the mirror vibrates the currents become unequal and the stylus writes

its story on the smoked paper of the drum.

The exact instant of an earth tremor is of importance to seismologists. Accordingly, a Telechron Timer is provided with a switch (top photo) which closes a relay once each minute. During this small interval a 20,000-ohm resistor shunts one of the galvanometer coils to produce a timing deflection which can be seen as a small wavy line on the record.

This equipment has accurately recorded practically all earthquakes reported by the U. S. Coast and Geodetic Survey. The wave form compares favorably with those obtained by much more complicated large observatory seismographs.

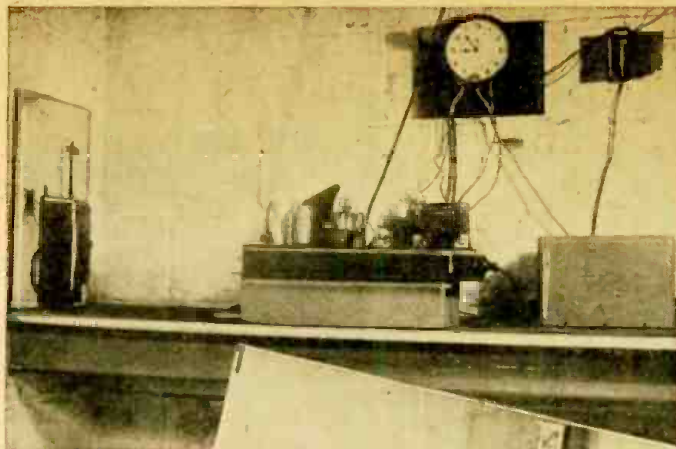

Top—Seismograph amplifier, power pack and timing unit. Bottom—the recording cylinder.

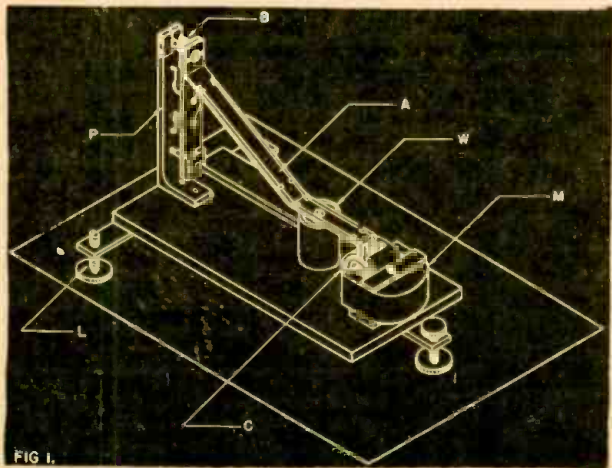
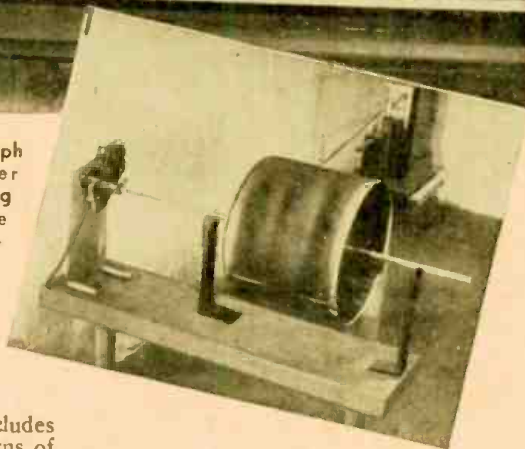

FIG. 1

Fig. 1, left—The seismometer, which picks up the tremors. Fig. 2—Schematic of the amplifier. Voltage-stabilized power pack and VR-150 control voltage to photocell.

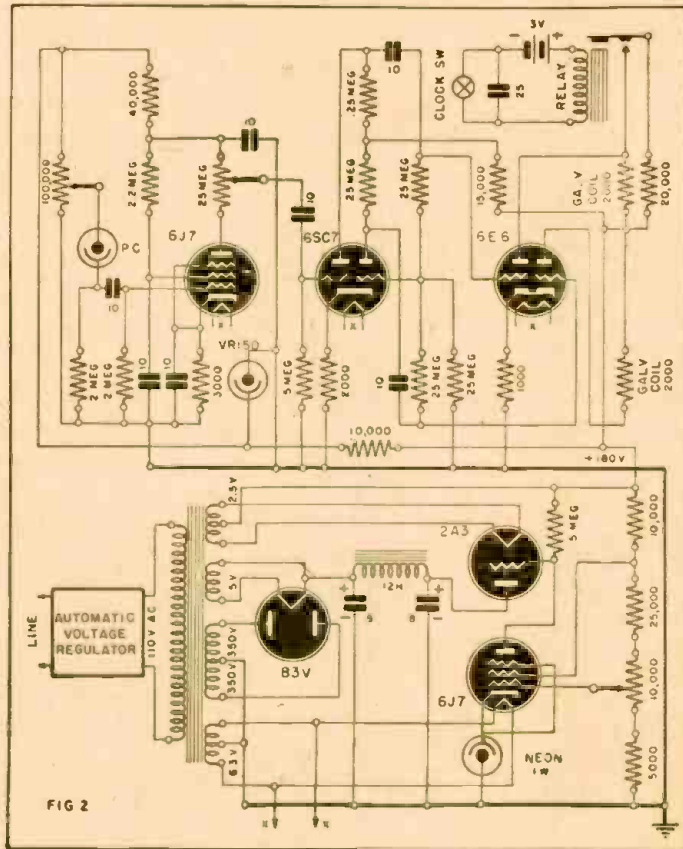

FIG. 2

Cross-Over Networks

By JACK KING

BECAUSE of the difficulty of designing a loud-speaker which will function efficiently over a wide frequency range, it has been common practice in FM radios and movie sound work to use a "woofer" for the lower frequencies and a "tweeter" for the highs. The tweeter is generally a low-power unit since the high frequency sound energy is small in comparison with the low. The woofer is a rugged, heavy-duty unit. The job of dividing the electrical energy into two paths falls to the dividing network. A simple type of network is shown in Fig. 1. R is the voice coil resistance or speaker resistance in ohms, C is the capacity in farads and f_x is the cross-over frequency in cycles. L is the inductance in henries.

The circuit action is easy to visualize. A condenser is connected in series with the high-frequency speaker. Since condenser reactance decreases as frequency rises more high frequency current gets through to the tweeter than low frequency current, thus favoring the highs so far as the tweeter is concerned. Also note that in Fig. 1 a coil is connected across the high frequency speaker terminals. Thus the shunt current through the coil will be greater at the lower frequencies, since the coil has low reactance at these frequencies. As the frequency rises the coil current is decreased and the current in the high-frequency speaker rises.

The opposite action occurs so far as the low frequency or woofer speaker is concerned. It has a condenser in parallel with it. The shunt reactance of the condenser decreases as the frequency is raised, shunting away an ever greater amount of current from the woofer at higher and higher frequencies. Current is directed into each speaker in its own frequency range, and shunted around it at the other end of the audio scale.

Still another form of dividing network is shown in Fig. 2. The action here is somewhat the same as in Fig. 1, but note that as X_c decreases not only is there less opposition to the flow of high frequency signal current in the tweeter, but also an increased shunting of high frequency current away from the woofer—through the condenser and tweeter. The choke coil L opposes the high frequency current but offers relatively little opposition to the lower frequencies. Note that, looking into the input terminals of this network at a particular frequency, we may run into parallel resonance. At such a frequency the load on the source connected to the input will drop and the output voltage of the source will rise, which may cause feedback and oscillation in an amplifier system. The damping action of the speaker resistances, however, would tend to decrease the Q of the resonant circuit and to give a broad peak, so that in all probability the resonant build-up would be so small as to

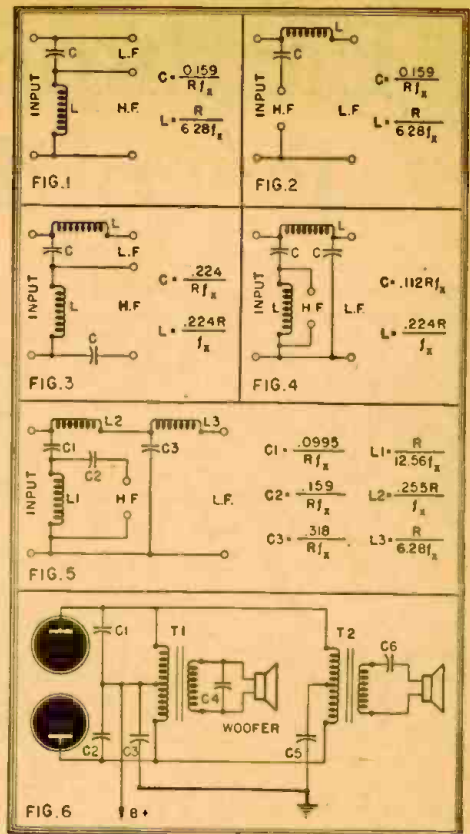

Several loudspeaker cross-over systems. Fig. 6, bottom, is a highly practical, flexible circuit.

call for no design features to overcome it. The type of network shown in Fig. 3 is sometimes used. The C and L values are (Continued on page 307)

Uses for the OA4-G Gas Tube

By NATHANIEL RHITA

THE OA4-G gas triode is known to most radiomen as a tube which occupies a prominent place only in the manual. Outside its use as a rectifier in certain automobile sets, the average serviceman considers it of little importance. Considering the growing importance of control circuits, this attitude is a mistake.

Many advantages may be gained by using a gas tube in relay circuits. It is found that relays do not operate at exactly the same voltage each time. Near breakdown this causes a tendency to chattering. If the relay is used in the plate circuit of a gas tube it is subject to either no current or to full current. Thus it opens or closes quickly and positively. Circuit efficiency with the tube is practically equal to that without it, since no filament power is required.

Characteristics of the OA4-G are as follows:

Peak cathode current	100 Ma max.
D.C. cathode current	25 Ma max.
Grid voltage drop	60 volts approx.
Anode drop	70 volts approx.

Theoretical operation of gas-filled tubes have been discussed in recent issues of *Radio-Craft*.

A basic development using the OA4-G is shown in Fig. 2-a. A patent for this arrangement has been issued to Harmon B. Deal of Glen Ridge, N. J. A relay is shown in the plate circuit with a condenser across it to smooth the plate current and prevent relay chattering. When the tube ionizes, the

external circuit is closed. The ratio of Z to Z' determines the point of breakdown, and each may be of the order of a megohm so that the power loss is in microwatts.

The impedances may take many forms. In Fig. 2-b two resistances are shown. If these are of opposite temperature coefficients (or even unequal coefficients) rise in temperature will vary their ratio and result in tube operation. The controlled circuit may either contain an indicator or a device to control the temperature. Fig. 2-c, shown as controlled by a capacitance change, may be used in connection with height of a liquid, for example, so that at a given height, the relay is thrown. In Fig. 2-c, sound applied to a microphone causes increase of voltage between cathode and starter-anode to actuate the tube. Light energy operates the circuit of Fig. 2-d, since it decreases the resistance of the photocell, again increasing voltage between cathode and starter.

All circuits must originally be adjusted so that the tube is operating below but near its breakdown point.

OTHER CIRCUITS

Another form of circuit is shown in Fig. 3, which may be used for flame control. In (Continued on page 303)

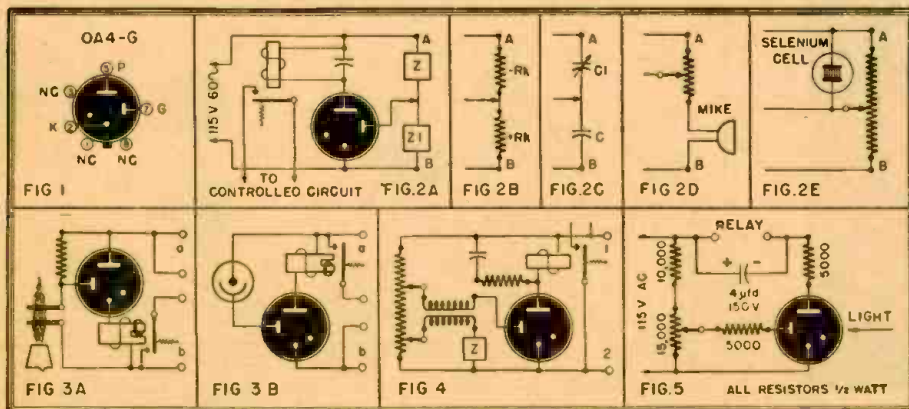

Fig. 1—Base connections of the OA4-G. Fig. 2—Basic relay circuit, used as shown in 2B, C, D and E. Figs. 3A and 3B—Sensitive relays. Fig. 4—A relay operating on small impedance changes. Fig. 5—OA4-G used as a photocell.

SPEECH AMPLIFIER

PART V — MORE TRANSFORMER PROBLEMS

By ROBERT F. SCOTT

At a specific high frequency there is a reaction within the circuit which causes the response curve to have a peak which is higher than the intermediate value. This peak is due to the fact that in a series resonant circuit the capacitance, inductance, resistance and source of voltage are all in series. Under these conditions, the reactances are equal and opposite and the current flow in the circuit is limited only by the resistance.

One method of suppressing the peak is to shunt the secondary of the transformer with a resistor which may vary between 250,000 ohms and one-half megohm. To resort to such practices is to admit that the transformer is of poor quality. In this case the resistor reduces the gain at mid-frequencies, thus giving more uniform frequency response.

Although it will require a little study to understand all of its applications, there is a curve called "The universal curve for transformer coupled amplifiers" which is very interesting to those who study it. It is useful in determining the response which may be expected from a transformer coupled stage if certain conditions are known. The low-frequency response of a transformer stage may be more easily computed from this curve since the factors governing this end of the band are more easily available to the experimenter. The curve shows that when the reactance of the primary divided by the effective plate resistance is equal to 5 the gain is equal to that of the intermediate frequencies. It begins to decrease as the reactance of the primary is decreased, and when the two factors are equal the gain has dropped to 70.7% of its intermediate frequency value.

The high frequency response factors may be somewhat more difficult for the student or home experimenter to determine without elaborate experiments and equipment. Note that it is the Q of the circuit which determines the magnitude of the peak. This curve is shown in Fig. 1.

Although this article was not written in

an attempt to make sound engineers, suppose we take a peek at some of the problems which confront the designing engineer of audio transformers.

His job is to design a transformer which is to serve as a means of coupling the relatively low impedance of a plate circuit to the grid circuit of the following stage with a specific turns ratio and good all-around frequency response. If the transformer is to provide ample low frequency response, the inductance of the primary winding will necessarily be high, so impedance at low frequencies will be ample to give a high voltage output. At the same time, the distributed capacitances of the windings should be kept low to insure minimum shunt capacitances. If high inductance of the primary is to be maintained it will be necessary to accomplish it by one of three means.

Perhaps the first method to be considered would be to increase the number of turns

in the primary. The disadvantages are: an increased number of turns increases the number of secondary turns if the turns ratio is to be preserved; secondly, the distributed capacitance of both windings would be increased. There is also the problem of finding space for the additional turns, which can be met only by increasing the size of the core. This would increase the cost of the whole and the finished product would be much larger and heavier and more likely to introduce hum into the circuit.

A second method would be to increase the size of the core, maintaining the original number of turns. This would be objectionable for the reasons just given.

Perhaps the most widely used method by the manufacturers of small high-quality transformers is to use a very highly permeable material for the transformer core. This is known by such trade names as Permalloy, Hiperam and the new Hipersil cores. Possibly the only objection to this method is the increased cost.

Fig. 1 — Universal curve for transformer-coupled amplifiers. The resonance peak at high audio frequencies is shown to depend on the transformer's ratio of resistance to reactance.

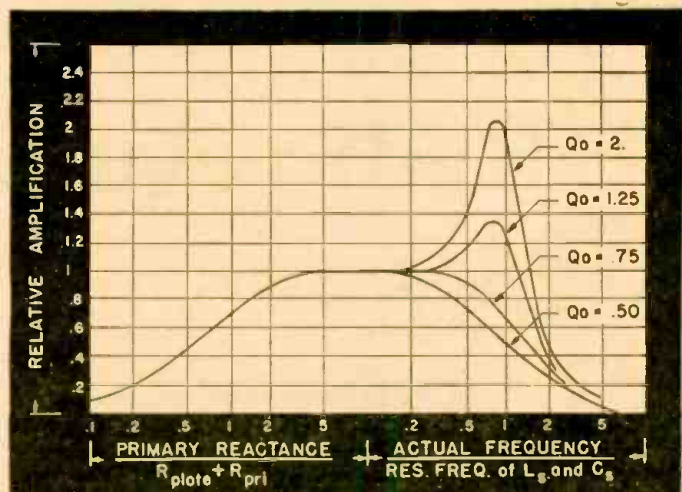

Nazi's Radio Robot Tank Grows

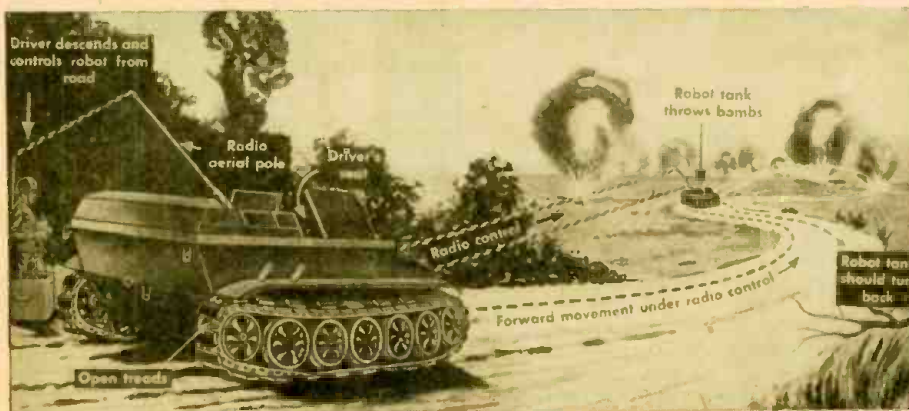

Latest of the "doodle-bugs," several of which have been described in *Radio-Craft*, is this full-size radio-controlled tank. The operator brings the new "secret" weapon up to the area of heavy fire, dismounts and guides it forward with his radio control apparatus to a point where it can inflict damage with its bomb-thrower. As the tank is completely defenseless when unmanned, it is not as dangerous a weapon as might be imagined. Numbers of these robot tanks have been captured intact and their mechanism carefully examined.

The tubes most suited for service in transformer coupled amplifiers are those designed for voltage amplifier service and having an amplification factor between 8 and 35 and a plate resistance between 6500 and 1800 ohms. Such tubes generally have a plate current which would range from 2 to 12 ma. at the correct operating point. Tubes which have these specifications are usually triodes. The plate resistance is sufficiently low to provide good output and frequency response. The small current drawn through the winding of the transformer will not be sufficiently high to saturate the core.

Occasionally it is desired to operate a pentode tube in a transformer coupled stage. Since the plate resistance of most pentodes is much higher than the limits set for transformers to work from, a resistance equal to the plate resistance for which the transformer was designed to work is shunted across the secondary winding. The response will then be the same as for a triode and the amplification will be a function of the transconductance. High- μ triodes as the 6F5, 6Q7 and 6K5 are seldom employed for service in transformer coupled circuits but if it is desirable to use them, they should be treated in the same manner as pentodes.

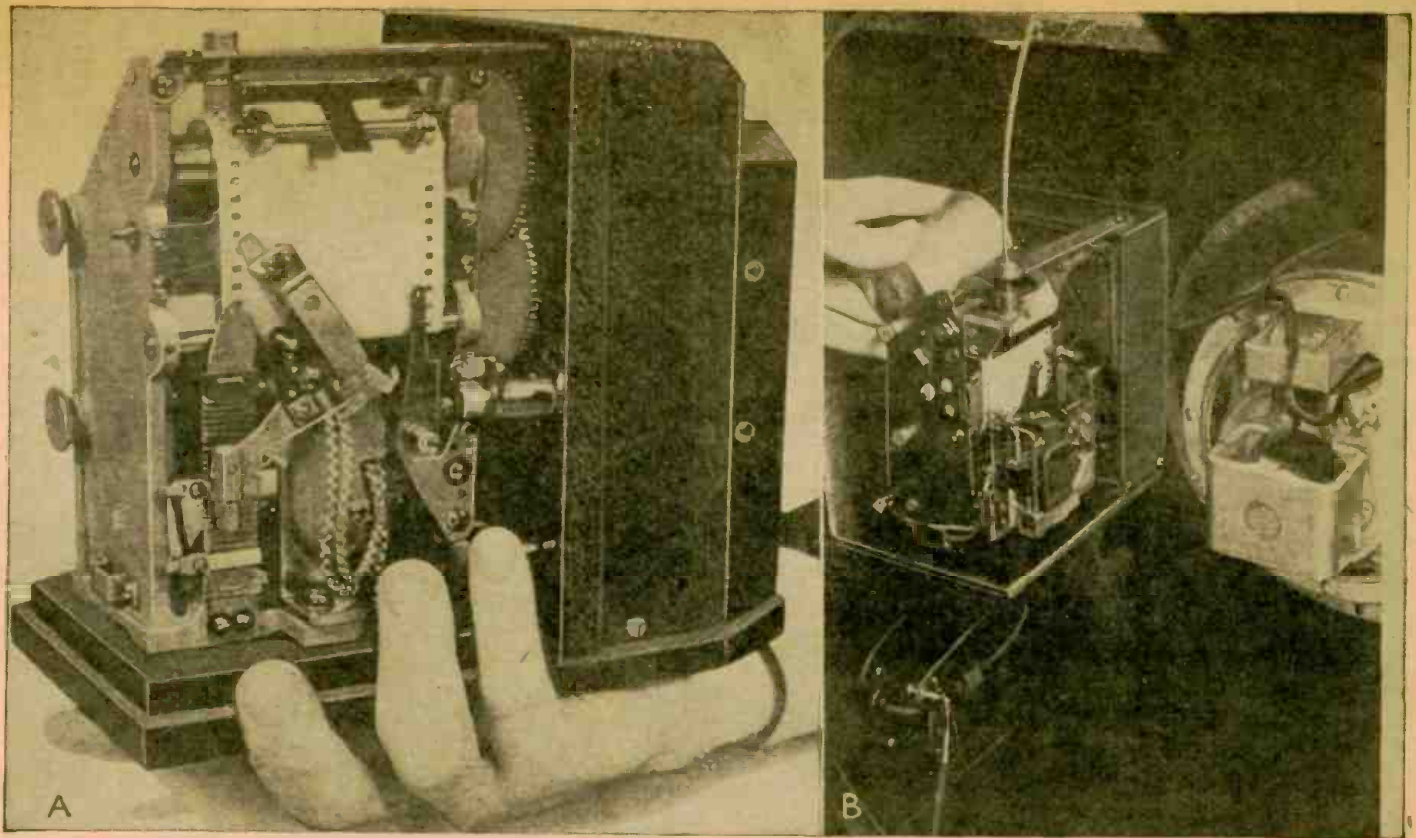

Photo A: Bowden Wire Audimeter, showing size; Photo B, an installation in a radio receiver.

Radio-Audience Meter

By I. QUEEN

A SERIOUS problem confronting radio sponsors is the determination of audience reaction. This is an important consideration to an advertiser who spends large sums to create goodwill and who wishes to reach the most people with the program type most desired. Through the media of popularity polls, telephone calls to listeners and fan mail, it is possible to gain a slight knowledge as to the listening habits of the unseen au-

dience, but these media are distinctly limited as to scope.

During the past few years, a new method of measuring audience reaction has been developed. It is now possible to completely and accurately determine the time of day, the length of time and the program to which a radio set has been tuned, and even whether the commercial announcement was tuned out! The basis of this method is the Nielsen Audimeter, a small graphic recording instrument through which is threaded a wax-coated tape. This meter, with the listener's co-operation, is installed in a typical home and connected in such a way that whenever the radio is turned on and a station tuned in, a stylus makes a minute-by-minute recording of the frequency and time. The tape moves uniformly with time even when the radio is off. After a 28-day period, the tape is renewed by a fieldman and sent to the main office for analysis. Fig. 1 shows a completed recording.

A few hundred Audimeters have been distributed in typical homes in Illinois, Wisconsin, Indiana and Ohio since 1938. As a result of a cross-section placement many interesting facts have been brought to light regarding the radio audience. As shown in Photos A and B, the meter is small enough to be placed inside the average radio cabinet. When used in connection with the midget type of receiver, a special type of Audimeter (Photo C) may be installed in a closet or other convenient place, at some distance from the radio.

For speed and accuracy in analyzing the tapes as they are collected, special decoding machines have been developed. Data may

be segregated and interpreted by income classes, city size, racial groups or family size. To complete the survey, a household inventory of products used by the family is taken at the time of tape renewal.

(Continued on page 309)

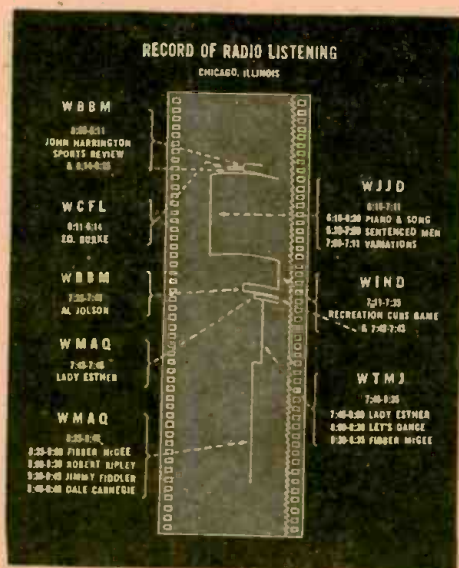

Fig. 1—A sample of tape from the Audimeter. Lateral displacement of the line indicates the station to which the radio is tuned, and length of line, the time it is kept tuned in.

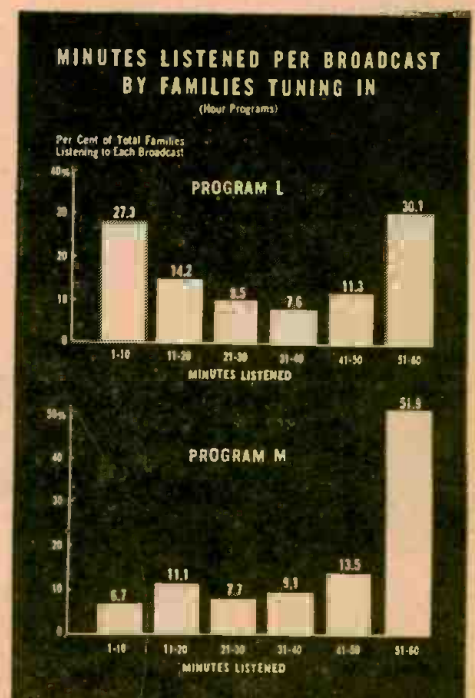

Fig. 2—A comparison of two typical one-hour broadcasts, showing the length of time various portions of the audience remain tuned in.

**MOST
OFTEN
NEEDED**

RADIO DIAGRAMS



1942 4 Out of 5 Diagrams You Will Ever Need

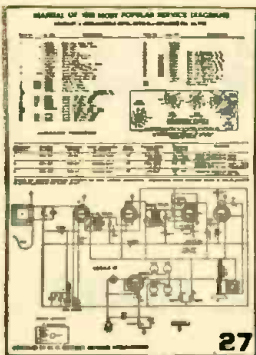

Find radio faults quickly. Make the needed repairs in any radio. Save time on every job. This large, new and inexpensive diagram manual has the circuit for every popular 1942 radio set. 4 out of 5 diagrams you will ever need are included.

WITH ALIGNMENT DATA
Clearly printed circuits, alignment data, parts lists, service hints are the facts you need to speed up War-time servicing. Repair radios quickly and properly—follow the factory instructions given in these manuals. 351 models of 40 largest manufacturers. 192 fact-packed pages. Large size, 8 1/2 x 11 in. Manual style binding. Price, postpaid, only **\$2.00**

NEW, POPULAR, LOW-PRICED MANUALS

1941

These easy-to-apply, inexpensive manuals will help you repair radios faster. This volume covers 1941 models, with alignment data, I.F. peaks, and replacement parts lists. Compiled by M. N. Beitman, radio serviceman for many years, author, and teacher. Re an expert in radio servicing; simplify your work. 192 pages 8 1/2 x 11 inches. Only **\$2.00**

1940

Let this important manual give you over 80% of all 1940 circuits you will ever need, acquaint you with new developments, train you to service quickly and efficiently millions of sets. Data on F.M., portables, recording, etc. 417 models of 43 manufacturers. 208 pages. Net price.. **\$2.00**



1939

Another handy manual of the most popular diagrams you need. Circuit data, hints and information are time-savers and money-makers for you. Let these diagram manuals guide you to easier service work. Why try to get along without helpful diagrams? Use this volume with 192 pages of diagrams of 39 makes. Only .. **\$2.00**

Most Popular Models Made by:

Philco, RCA, Zenith, Sears, GE, Emerson, Belmont, Detrola Radio, Fada, United Motors, Westinghouse, Arvin, Majestic, Stewart-Warner, Admiral, Delco, Stromberg-Carlson, Western Auto, Sparton, Motorola, Wards, Gamble, and many others.

Other Practical Radio Manuals

How to MODERNIZE Radios for Profit



Cash-in by improving audio circuits, modernizing cabinets, adding features usually found only on late model sets. Practical job sheets with schematics and photographs make the work easy. You are told how to obtain modernization work, what to charge, and how to complete the job quickly and efficiently. The complete, large size, 8 1/2 x 11 in. manual is priced at only **\$1.00**

RADIO SERVICING COURSE-BOOK

Let this 22-lesson course help you fix and adjust any radio set. Easy-to-understand explanations; hundreds of simplified diagrams, pictures. Practical hints. Quickly learn how to make needed tests, locate faults, complete the repair. Learn new speed-tricks of radio fault finding, case histories of common troubles, servicing short cuts, extra profit ideas. With this information you will save enough time on a single radio job to pay the special \$2.50 price for the complete course of 22 money-making lessons. Many active servicemen used this reduced price radio training for brush-up and study of new service methods. Reprinted in 1944 with information on signal-tracing, television, visual alignment, P.A., photocells, etc. All about AVC, how to use an oscilloscope, what is feed-back, resonance action, and every other fact you must know to be more expert in your work. Large size: 8 1/2 x 11 inches. 224 pages. Price only **\$2.50**



PRACTICAL RADIO MATHEMATICS

Introduces and explains the use of arithmetic and elementary algebra in connection with units, color code, meter scales, Ohm's Law, alternating currents, ohmmeter testing, wattage rating, series and parallel connections, capacity, inductance, mixed circuits, vacuum tubes, curves, the decibel, etc., etc., and has numerous examples. Net..... **25c**

See Your Radio Jobber or Send Coupon

1926-1938

The most popular volume of the series. Will pay for itself with the time saved during the first day of use. Includes all the popular old timers. Save hours on every job. 427 diagrams of the most-serviced radios of this period, with parts lists and alignment information. 240 pages, 8 1/2 x 11 inches. Sold with a money back guarantee. Price, postpaid, **\$2.50**



Compiled by M. N. Beitman, radio engineer, teacher, author, & serviceman.

SAVE HOURS ON EVERY JOB

Be ready to make repairs in minutes instead of hours. You will be called upon to fix hundreds of models listed in these easy-to-use manuals. Tackle each job with the needed help found on every page in these handy service manuals. Greatest bargain in diagram books. Send your order today. Use these manuals this week.

NO RISK TRIAL ORDER COUPON

SUPREME PUBLICATIONS, 9 S. Kedzie Ave., Chicago 12, ILL.

Ship the following manuals: (Money back guarantee).

1942 1941 1940 1939 1926-1938

Also send other Supreme Publications as listed below:

I am enclosing \$..... send postpaid.

Send C.O.D. I am enclosing \$..... deposit.

Name:

Address:

(Use Coupon or Send Order in a Letter)

Supreme Publications

PUBLISHERS OF RADIO BOOKS, MANUALS, AND DIAGRAMS

REPAIR ANY KIND OF PREPARE AT HOME FOR A GOOD-PAYING

RADIO TROUBLESHOOTER'S HANDBOOK

A DEFINITE, DEPENDABLE GUIDE FOR DIAGNOSING, LOCATING AND REPAIRING RADIO RECEIVER TROUBLES

If you repair Radios for a living—or even if you only "tinker" with sets occasionally—here is a book you simply cannot afford to miss!

This big, new, completely revised 3rd Edition of A. A. Ghirardi's world-famous RADIO TROUBLESHOOTER'S HANDBOOK is just what the name implies—a complete guide to better, faster servicing on practically every type of Radio Receiver now in common use in this country. When a receiver comes in for repairs, simply turn to the Case History section of the book. Look up the notes on that particular make and model—and, chances are, you'll find exactly the information you require to diagnose the trouble accurately and fix it properly.

Thus the book eliminates the need for extensive testing ON A BIG PERCENTAGE OF ALL JOBS. It helps the busy wartime serviceman repair two radios in the time ordinarily required for one. It helps you handle tough service jobs in half the usual time—repair cheap sets at a real profit—and, equally important, to substitute today's limited supply of tubes and parts to make them take the place of units you can no longer obtain. It is an invaluable book for helping train new service helpers. There is no better way of acquiring an actual working knowledge of common radio troubles and how to fix them in a hurry!

CUTS TESTING TIME **IN HALF IN HALF**

This new 3rd special wartime edition of Ghirardi's Radio Troubleshooter's Handbook is completely revised and much larger than previous editions. Nine additional sections of vital new material have been added. Actually, 404 pages are devoted to a Case History Compilation giving common trouble symptoms (and showing just how to repair them) for over 4,860 models of the 202 most popular makes of receivers. Often these case histories

entirely eliminate the need for testing a set. ALMOST ALWAYS, they save from 25% to 50% of the time you would normally require for the job. "I can't see how I ever got along without your new Radio Troubleshooter's Handbook," writes Vernon Taylor of Elgin, Texas. "It has helped me fix twice as many radios in a day's time as I could fix before owning this book!"

COMPLETE DATA ON 75 VITAL SERVICE SUBJECTS

This Case History Compilation, however, is ONLY ONE OF 75 VITAL SERVICE SUBJECTS covered in this new 3rd edition. Never before has such a wide variety of useful servicing information been presented so authoritatively within the covers of a single volume! There are hundreds of pages of charts, graphs, and data—all designed to HELP YOU REPAIR MORE RADIOS EASIER, AND IN LESS TIME.

There are I-F alignment peaks for over 20,000 super-hets; a big section on I-F transformer troubles; and A NEW TUBE CHART DESIGNED FOR WARTIME SERVICE NEEDS that servicemen themselves say is worth the entire cost of the book. This chart gives complete information on every tube type and gives prac-

tical hints on how hard-to-get types may be interchanged or replaced with available types.

Dozens of other charts, tips and helps make the Radio Troubleshooter's Handbook absolutely indispensable to busy servicemen at a time when test equipment is scarce, when many parts must be substituted, and when it is more necessary than ever before to have COMPLETE AND RELIABLE service reference data at your fingertips!

The book is yours complete for ONLY \$5 (\$5.50 foreign)—and it comes to you on an ABSOLUTE 5-DAY MONEY-BACK GUARANTEE BASIS. Order your copy today while the available supply lasts! You'll find the book will actually pay for itself the first day you use it!

I WONDER WHAT TO TRY NEXT?



MODERN RADIO SERVICING

HERE'S HOW TO LEARN MODERN RADIO SERVICE WORK

at home — without an instructor

How would you like to have Radio's foremost instructor always at your side to guide you in every phase of service work—answer your questions—show you short cuts—explain the theory and practical operation of radio test equipment—tell you how to make the best possible use of your time—and help solve your problems as they arise?

Actually, your ownership of Ghirardi's 1300-page MODERN RADIO SERVICING means just about that! To the beginner, this big book is a practical course in radio repairing that is easily learned at home in spare time. To the veteran, it is an "Open Sesame!" of sound, intensely

practical information—the only single, inexpensive book that gives a thorough explanation of the inner workings of all Test Instruments; Receiver Troubleshooting Procedure; Circuit Analysis; Testing and Repair of All Component Parts; Installation, Adjustments, and Maintenance, etc. Tells you WHAT to do and HOW to do it—even to the point of showing you exactly how to build your own test equipment. Contains over 706 illustrations, 720 self-testing review questions, and covers 766 different topics! Where else can you get data like this for only \$5 complete (\$5.50 foreign)? 5-day Money-Back Guarantee.



SAVE MONEY!

Make your technical library complete—keep it up-to-the-minute and profit accordingly! Get both Ghirardi's RADIO TROUBLESHOOTER'S HANDBOOK and Ghirardi's MODERN RADIO SERVICING—a big \$10 value for only \$9.50 (\$10.50 foreign). Use coupon today!

NEW WARTIME 3rd EDITION

The Big 744-page Manual-size Servicing Data Book that Tells You What to Do — and Exactly How to Do It.

Pays for itself in time saved on the very first job! Only \$5 complete

GHIRARDI RADIO BOOKS ARE SENT ON A 5

RADIO EQUIPMENT

JOB IN THE RADIO-ELECTRONIC FIELD

RADIO PHYSICS COURSE

HERE IS COMPLETE BASIC RADIO-ELECTRONIC TRAINING FOR ONLY \$5

Just starting out in Radio? Looking for COMPLETE authentic training that starts right at the beginning, takes no previous knowledge for granted—and that is available at a price you can easily afford to pay?

Then Ghirardi's famous RADIO PHYSICS COURSE is just the book for you! Here, in a single, fully-illustrated 972-page volume is a miracle of modern Radio-Electronic training—sold at a small fraction of the price you might expect to pay—and backed with a 5-DAY MONEY-BACK GUARANTEE that makes you the sole judge of whether or not you will want to keep it. You cannot lose!

Everything that can be done to make learning Radio-Electronics easy for you at home has been done in Ghirardi's RADIO PHYSICS COURSE. No previous training is necessary. All you need is a little spare reading time—and a desire to get started RIGHT for a profitable future in any of Radio-Electronics many branches, from servicing and repair work to Aviation, Military, Broadcasting, Manufacturing, Public Address, and many others. Remember: If this big book was broken into sections and sold as a course you might easily expect to pay \$50 or more for it. As it is, you buy it COMPLETE for only \$5 (\$5.50 foreign)!

YOUR MONEY BACK IN 5 DAYS

If Ghirardi's big, 972-page RADIO PHYSICS COURSE BOOK doesn't teach you RADIO-ELECTRONIC fundamentals FASTER and at LESS COST than any other book or course!

There is no guesswork when you buy Ghirardi's famous RADIO PHYSICS COURSE book, because—

This same inexpensive book has given more people their basic training than any other ever published. It is tried and tested. It is more widely endorsed by men already in Radio-Electronics. It is more universally used for home study, and more widely used in more U. S. Army Signal Corps, Navy, and civilian schools and colleges than any other. Would you want any better proof than this?

What other books and courses skim over,

RADIO PHYSICS COURSE explains fully. It even contains OVER 300 PAGES on the all-essential foundation knowledge of Electricity, without which no Radio-Electronic Training could possibly be complete.

Actually, this famous volume gives you the scope of 36 different courses in one—packed into an easy-to-follow, 972-page book with 508 clear illustrations, and 856 self-testing review questions—all for the price of only \$5 (\$5.50 foreign).

Send for it today! Judge it for yourself—in actual comparison with any other book or course you can name!



LET 817 RADIO MEN GIVE YOU THEIR VERDICT!

Recently we contacted a mixed group of 817 Radio instructors, servicemen, Radio technicians in the Armed Forces, in broadcast stations, manufacturing plants, etc.—and asked them to tell us what they thought of the various books and courses offered to Radio beginners. AND WE MADE A REAL DISCOVERY! Nine out of ten of them—728 to be exact—wrote back that Ghirardi's RADIO PHYSICS COURSE is their choice as the most understandable, thorough, and inexpensive Radio book—far better than any other book or course they have ever seen.

MORE TRAINING FOR LESS MONEY

Certainly you CAN'T go wrong in following the lead of men like these! Order today. Use this coupon. Get started at once! Our 5-Day Money-Back Guarantee is your complete protection!

IMPORTANT!

We don't have to tell you that paper and book-binding materials are mighty scarce—and getting scarcer! While the present supply of Ghirardi Radio Books is large enough for immediate needs, we cannot, of course, guarantee deliveries once this stock is exhausted. That's why we earnestly suggest that you protect yourself by ordering YOUR books today!



A. A. Ghirardi
Radio's most widely read technical author. Follow his articles in this and other leading Radio magazines each month.

THE
WORLD'S MOST
FAMOUS COURSE
FOR BEGINNERS

No Previous
Training
Required

RADIO
PHYSICS
COURSE
BY
ALFRED A. GHIRARDI

Used in more U. S. Army
Signal Corps, Navy, and
civilian schools, and for
more home study than
any other book of its kind.

Listed by the U. S. Office
of Education for Pre-Induction
"Fundamentals of Radio
Course".

THE 3 GREATEST VALUES IN MODERN RADIO TRAINING!

Sold at 1/10th the price you might expect to pay for such complete instruction.

Radio and Technical Division of MURRAY Hill Books, Inc., Dept. RC-25

232 Madison Ave., New York, 16, N. Y.

Enclosed find \$..... in payment for books checked below; or

send C.O.D. for this amount plus postage. In either case, if I am not fully satisfied,

I may return the books at the end of 5 days and RECEIVE MY MONEY BACK.

Ghirardi's RADIO PHYSICS COURSE \$5.00 (\$5.50 foreign) MONEY-SAVING COMBINATION OFFER

NEW 3rd Revised Edition of RADIO

TROUBLESHOOTER'S HANDBOOK \$5.00 (\$5.50 foreign)

MODERN RADIO SERVICING \$5.00 (\$5.50 foreign)

Troubleshooter's Handbook and Modern

Radio Servicing at the special price of only

\$9.50 FOR THE TWO (\$10.50 foreign).

Name

Address

City

Dist. Mailing

No. State

MAIL NOW ▶

TO YOU MONEY-BACK GUARANTEE DAY

BACK AGAIN...SOON



The Plan THAT GAVE 60,000 PIECES OF FINE TEST EQUIPMENT TO RADIO SERVICE DEALERS

Sure, you remember this big National Union Encyclopedia that showed all kinds of high-grade service and test equipment. It told you how to get the instruments and meters you wanted *free* with the exclusive N. U. Equipment Plan. And that plan was so popular that it was OK'd 60,000 times by radio service dealers!

AFTER THE WAR - MORE THAN BEFORE
Yes, a bigger and better Encyclopedia. More deals to bring you the modern test equipment you'll need to service radios, radio-phono-

graphs, television receivers and industrial electronic devices. After Victory, we'll make it easier than ever for you to equip your shop for more business and bigger profits . . . the exclusive National Union way!

NATIONAL UNION RADIO CORPORATION
NEWARK 2, NEW JERSEY

Factories at:
Newark and Maplewood, N. J.;
Landsdale and Robesonia, Pa.



NATIONAL UNION RADIO AND ELECTRONIC TUBES

Transmitting, Cathode Ray, Rectifying, Special Purpose Tubes • Condensers • Volume Controls • Photo Electric Cells • Panel Lamps • Flashlight Bulbs

World-Wide Station List

Edited by ELMER R. FULLER

As we stated in the January issue, we are presenting something new and different with this issue. On this page you will find a chart of the short wave stations in the United States showing at a glance on what frequencies they can be heard at any given time of day or night. It is our desire to present more of these in the future, and next month we may bring you a chart of

the British Broadcasting Corporation and its several stations.

DKSA is now being heard on several frequencies, and is heard fine business on 7.025 from 9 pm to midnight. The Japanese are now being heard best on 11.897 and 15.225 from 6:15 to 8:15 pm.

Below is presented the most often heard stations from 10 to 17 megacycles. They are preceded by a group of new stations

from 4 to 10 megacycles which have been added since the last issue went to press.

The Berlin stations are now using feminine announcers in their prisoner-of-war broadcasts. These newcomers to the mike are definitely not German. They could be WAC or Army Nurse Corps members who have been taken prisoner and have been made to broadcast for the Germans. All schedules are Eastern War Time.

Freq.	Station	Location and Schedule	Freq.	Station	Location and Schedule	Freq.	Station	Location and Schedule
4.700	ZQI	BRITISH WEST INDIES; 5 to 7:30 pm	11.680	GRG	LONDON, ENGLAND; on at 11 am and 12:30 pm.	12.115	ZNR	ADEN, ARABIA; 11:15 am. to 1:15 pm. daily
6.190	—	BERLIN, GERMANY	11.690	XGRS	SHANGHAI, CHINA; 11.15 am. to 12.30 pm.	12.270	—	HAVANA, CUBA; heard evenings
6.345	—	BERN, SWITZERLAND; on at 5:30 pm.	11.720	PRL8	RIO DE JANEIRO, BRAZIL; 9:35 to 10:45 pm.; off Sundays	12.445	HCJB	QUITO, ECUADOR; late afternoons and early evenings
7.025	DKSA	SENDER ATLANTIK; 9 to 12 pm.	11.725	JVW3	TOKYO, JAPAN; heard at 3:30 am.	14.800	WQV	NEW YORK CITY; Sundays only, 3:30 to 4:30 pm.
7.100	—	HAVANA, CUBA; 9:30 pm.	11.740	COCY	HAVANA, CUBA; heard at 1 and 3 pm.; probably on all afternoon	15.000	WWV	WASHINGTON, D. C.; U. S. Bureau of Standards
7.290	—	MOSCOW, USSR; 8:10 to 8:50 pm.	11.780	—	LONDON, ENGLAND; heard 7 to 10 pm.; also at 1 pm.	15.140	GSF	LONDON, ENGLAND; 10 am. to 4 pm.
7.370	KEQ	KAHUKU, HAWAII; 3 pm.	11.785	FZI	BRAZZAVILLE, FRENCH WEST AFRICA; about 3 pm.	15.155	SBT	STOCKHOLM, SWEDEN; 11 am.
9.480	—	MOSCOW, USSR; 8:10 to 8:50 pm.	11.880	VLR3	MELBOURNE, AUSTRALIA; heard at 10 am.	15.180	GSO	LONDON, ENGLAND; afternoons in African service
9.615	VLC6	MELBOURNE, AUSTRALIA; 8:30 and 11 am.	11.880	LRR	ROSARIO, ARGENTINA; heard at 8:30 pm.	15.190	CBFZ	MONTREAL, CANADA
9.625	XGCA	CHINA; 7 to 8:45 am.	11.897	JVU3	TOKYO, JAPAN; 6:15 to 8:15 pm.	15.200	DJB	BERLIN, GERMANY
10.000	WWV	WASHINGTON, D. C.; U. S. Bureau of Standards	11.970	FZI	BRAZZAVILLE, FRENCH WEST AFRICA; 8:30 pm.	15.225	JTL3	TOKYO, JAPAN; 6:15 to 8:15 pm.
10.169 (abt)	—	"STATION PARIS"; PARIS, FRANCE; press reports to NBC and CBS; no sked known; heard often at noon; 6:30 pm.	12.040	GRV	LONDON, ENGLAND; 11 am. and 1 pm.	15.230	VLG6	MELBOURNE, AUSTRALIA; on at 10 pm.
10.350	LQA5	BUENOS AIRES, ARGENTINA; 6:58 to 7:15 pm.	12.070	CSW	LISBON, PORTUGAL; heard at 2:30 to 4 pm.	15.260	GSI	LONDON, ENGLAND; heard at 11 am.
11.040	CSW6	LISBON, PORTUGAL; Brazilian beam; 6:45 to 8:45 pm.	12.110	HIX3	CIUDAD TRUJILLO, DOMINICAN REPUBLIC; noon to 5 pm.	15.315	VLO3	SYDNEY, AUSTRALIA; 12:45 to 1:45 am.; evenings to 10:45 pm.
11.405	—	DAKAR, FRENCH WEST AFRICA; "Radio Dakar" at 2:45 to 4:55 pm.				15.505	—	HAVANA, CUBA; 7:45 to 8:30 pm.
11.616	COK	HAVANA, CUBA; noon to midnight				15.750	—	MOSCOW, USSR; 6:45 to 7:25 pm.
11.680	CMCY	HAVANA, CUBA; heard at 11 am.				17.445	HVJ	VATICAN CITY; 11 am.
						17.730	BBC	LONDON; 7:30 to 11:15 am.

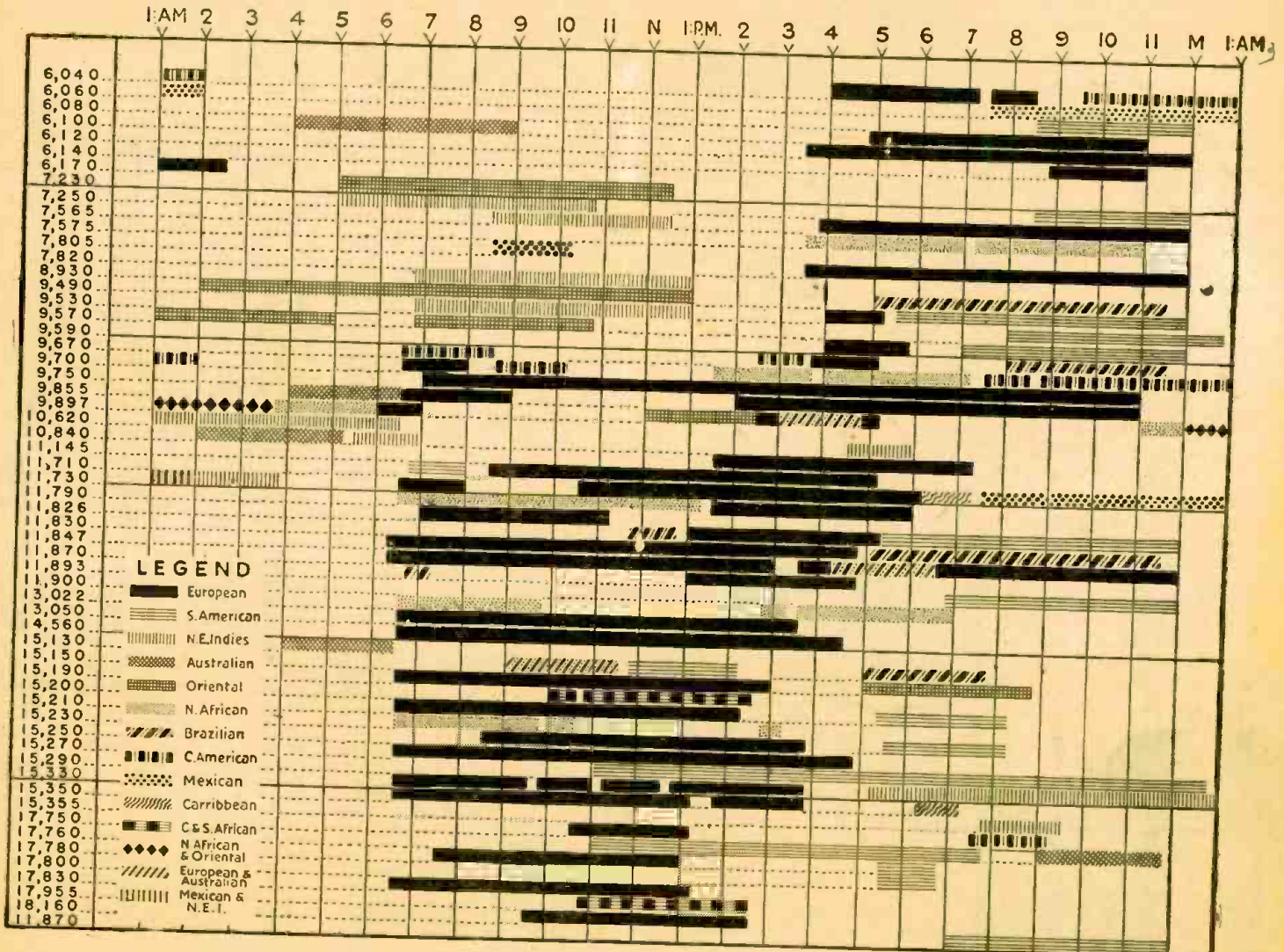

"Voice of America" Compiled from Official Sources by Elmer R. Fuller

New Radio-Electronic Devices

MAGMOTOR GENERATOR

Carter Motor Co.
Chicago, Illinois

BUILT with capacities up to 80 watts intermittent and 35 watts continuous duty, this new generator comes in a wide range of A.C. and D.C. voltages. In the A.C. line voltages up to 500 volts at 100 cycles, and in the D.C. line voltages up to similar power are available.

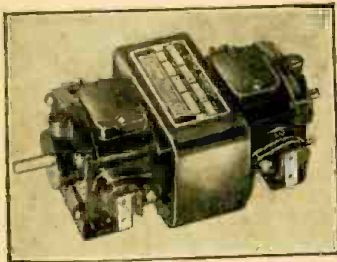

The units are suited for many uses where small reliable generators are needed. Mechanical Characteristics: Size $5\frac{3}{4}$ ins. long, $3\frac{11}{16}$ ins. wide and $2\frac{1}{2}$ ins. high; weight $4\frac{3}{4}$ pounds; shaft $\frac{1}{4}$ in. by 1 in. long. No motor is included and drive can be by direct couple, gear train or pulley.

The utilization of permanent magnet fields, instead of the conventional field coils, eliminates the necessity of a separate source to power that part of the generator. This is a saving both in space and wattage. Where batteries are at a premium, or where they are not readily available, and a gasoline or steam engine is used to turn the generator, this is a valuable feature and considerably increases the device's versatility. — *Radio-Craft*

GLASS SLEEVING

William Brand & Co.
New York, N. Y.

THIS new tubing has greater flexibility than has heretofore been associated with electrical insulation of this type. It is non-moisture absorbing, non-burning and will not fray, split or crack. Any color can be supplied and all are vivid and permanent.

TURBO Single Saturated Glass tubing provides fast, easy assembly and facilitates application by its ready color identification. It can be supplied in any diameter. — *Radio-Craft*



ALUMINUM LOUD-SPEAKER

The Langevin Co.
New York, N. Y.

THIS new loud-speaker, Type 26-B, is designed to operate with maximum intelligibility through high noise levels and with uniform distribution over horizontal angles of 120 and vertical of 40. It is designed for voice reproduction when used by itself or as an excellent high frequency component to a wide range system.

The unit is cast aluminum, equipped with heavy universal mounting brackets, and is designed for economy of installation. It handles power input of 40 watts when equipped with 2 Jensen U-20 drive units. This loudspeaker is 22 ins. wide, $14\frac{1}{2}$ ins. deep, 20 ins. high. — *Radio-Craft*

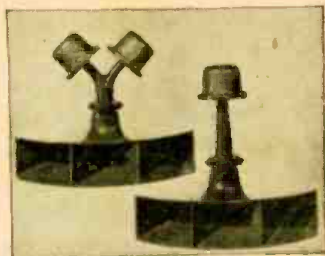

VACUUM-TUBE VOLTMETER

Reiner Electronics Co.
New York City

THE Model 450 Vacuum Tube Volt-Ohm-Milliammeter, incorporates many features which simplify operation and save time in production testing. Of particular importance is the wide frequency range A.C. Voltmeter which measures from 50 cycles to 50 megacycles; also the six D.C. voltage ranges, with input capacitance of less than 2 micro-microfarads and input resistance of 11 megohms all ranges; D.C. current ranges from 50 micro-



amperes to 1 ampere in six ranges. The ohmmeter is specially designed to aid troubleshooting and general laboratory measurement work with its 2% center scale accuracy. Model 450 Voltmeter is useful for such laboratory work as measuring amplifier gain, network response and output level. — *Radio-Craft*

ANTENNA TUNING UNIT

Andrews Company
Chicago, Illinois

THE primary purpose of the new Andrews Type 48 antenna tuning unit is to efficiently couple a vertical tower antenna to a coaxial transmission line.

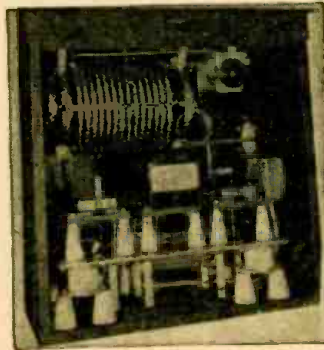

It does this by means of an L network, the elements of which are variable to permit adjustment for optimum performance.

Features are:

1. Built-in isolation filter, to permit connecting a coaxial transmission line to an ultra high frequency antenna on top of tower. This permits operation of a high frequency "talk-back" antenna on top of a low frequency tower. A standard broadcast station would use this feature to connect a coaxial transmission line to a phase sampling loop, or to an FM antenna.
2. Substantial steel weather-proof cabinet.
3. Built-in tower lighting filter, to facilitate feeding aircraft warning lights on top of tower.
4. Steatite insulation throughout.
5. Plug in meter positions, to facilitate temporary metering during adjustment.
6. Convenient outlet box, for soldering iron, extension light, etc. — *Radio-Craft*

ADJUSTABLE RHEOSTATS

Stackpole Carbon Company
St. Marys, Penna.

A NUMBER of new types and sizes of continuously adjustable carbon rheostats formed of carbon disc piles are available. Simply by changing the pressure applied to these piles, every possible resistance value within their range is made available without opening the electrical circuits in which they are connected. The pressure to vary the resistance to the most critical adjustment may be applied electrically, mechanically, centrifugally or hydraulically. — *Radio-Craft*

METAL TUBE EXTRACTOR

The BMP Company
Boonton, New Jersey

ELIMINATING the former hazards of tube extraction, the new BMP Metal Tube Extractor does away with burnt fingers, jiggling around to get the tube out and snapping caps. Constructed of one-piece steel, plain, zinc or cadmium plated, this amazingly simple device contains no screws, rivets or welds. With this extractor, just one firm pull is all that is needed in order to remove the hot tube. Designed and built to last a lifetime, it fits all standard size metal tubes. — *Radio-Craft*

MULTI-RECTIFIER

Green Electric Laboratories
New York, N. Y.

THIS single unit, a complete departure in terms of flexibility, allows for a range of from zero to forty-eight volts in a compact mechanism. Engineers and technicians will no longer be handicapped in their development work by the limitations now imposed upon them by orthodox rectifiers, generators or batteries.

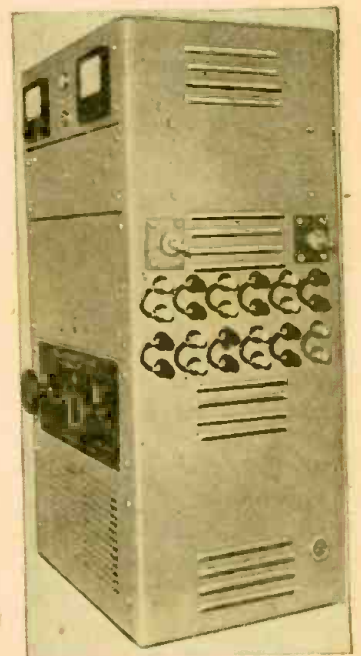

This new Multi-Rectifier incorporates six selenium rectifier sections which may be interconnected by external links to provide four D.C. ranges. Available for operation from all standard line voltages.

0-8 V., max. capacity 100 amp.
0-16 V., max. capacity 50 amp.
0-24 V., max. capacity 35 amp.
0-48 V., max. capacity 18 amp.
— *Radio-Craft*

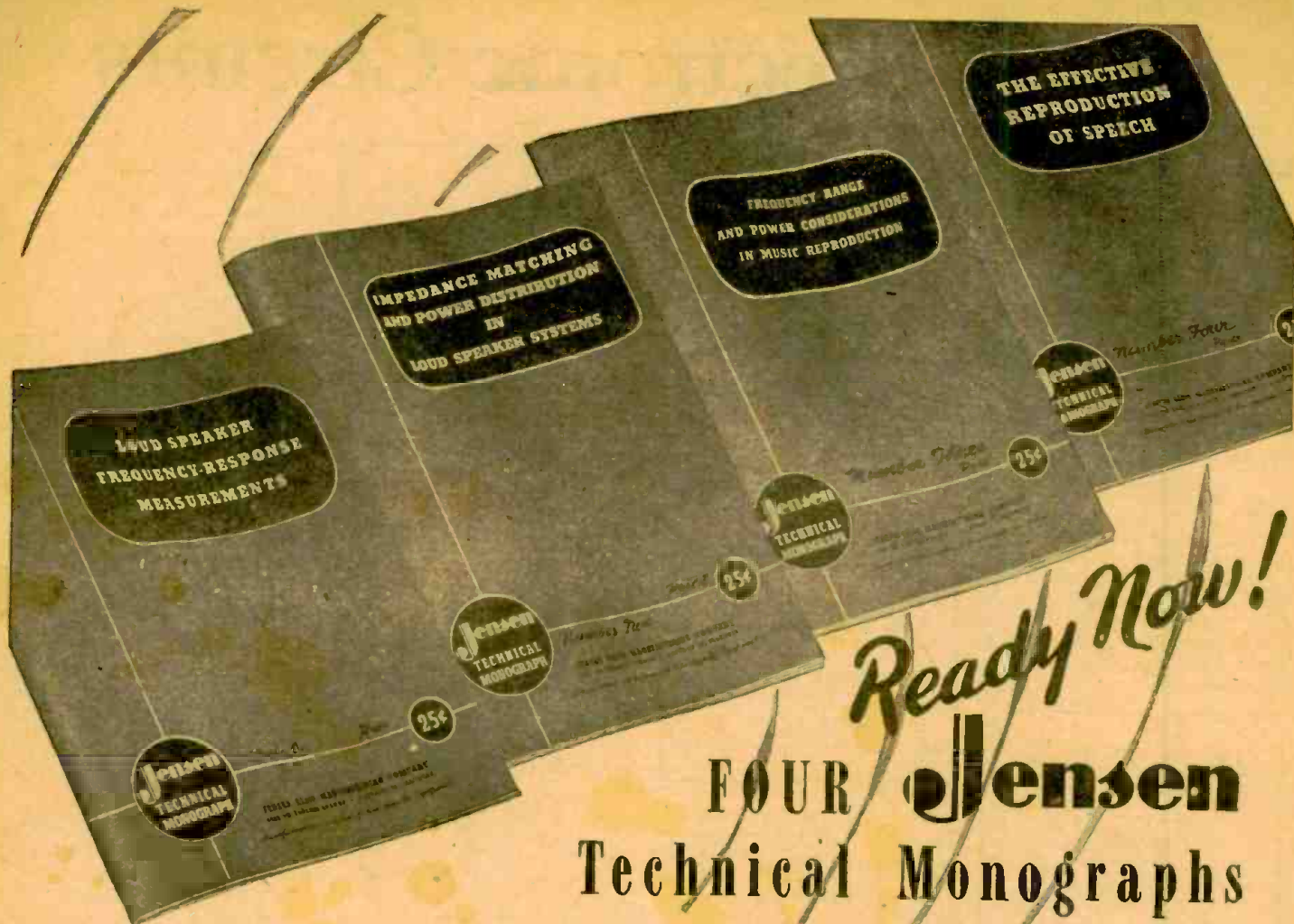

Ready Now!

FOUR Jensen Technical Monographs

EVERYONE interested in the reproduction of sound—engineer, tradesman, instructor, student or layman—should own these four Monographs. Published by the Jensen Technical Service Department in the interest of improved sound reproduction, they are the first four numbers of a series. Up-to-date in factual information, replete with useful charts, graphs and tables, they supply a world of data, heretofore unobtainable, to guide in the selection, installation and operation of loud speakers. You will want not only these four numbers but the rest of the series as announced from time to time.

MONOGRAPH No. 1: "Loud Speaker Frequency-Response Measurements." Deals with one of the most interesting and controversial subjects in the field of acoustics. Discusses, among other topics, frequency response of the human ear, the influence of environment on frequency response, the practical aspects of frequency-response measurements. Amply illustrated with charts and graphs.

MONOGRAPH No. 2: "Impedance Matching and Power Distribution." Discusses such subjects as multiple speaker connection, volume control, design of efficient transmission lines, and conversion of volume levels to power and voltage. The text is supported by

twenty-eight drawings and tables. More than a score of questions are described, illustrated and solved, including a comprehensive sound system for a military installation.

MONOGRAPH No. 3: "Frequency Range in Music Reproduction." What frequency range is needed for high fidelity reproduction? What are the maximum, useful audio frequency ranges under actual listening conditions? What are the practical limitations on high fidelity reproduction even if perfect transmission, reception and reproduction were possible? How much change in high frequency cut-off is required to be just noticeable to the listener? All these and many more questions are answered in this Jensen Monograph.

MONOGRAPH No. 4: "The Effective Reproduction of Speech." Explains why faithful speech reproduction requires a frequency band almost as wide as for music, while amplified speech for strictly communication purposes may be reproduced satisfactorily within a narrower band because in this case the principal emphasis is on such things as articulation, loudness, masking, and power requirements. Presents useful conclusions and practical information for everyone interested in speech reproduction.

Get any or all of these Monographs today from your Jensen jobber or dealer. Fill in the coupon and send with it 25c for each copy desired, or clip a dollar bill to the coupon and get all four.



FREE to men in the Armed Services, and to Colleges, Technical Schools and Libraries.

JENSEN RADIO MFG. CO.

6633 South Laramie Avenue, Chicago 38, Illinois

Send me:

- Loud Speaker Frequency-Response Measurements
- Impedance Matching and Power Distribution
- Frequency Range in Music Reproduction
- The Effective Reproduction of Speech

(Check one or more. Send 25c for each book ordered.)

NAME _____

ADDRESS _____

CITY _____

ZONE _____

STATE _____

Radio-Electronic Circuits

COIL-LESS OSCILLATOR

Most oscillators require at least one coil or transformer. Here is a circuit which is giving me very good results and makes no use of any coil whatsoever. Only several condensers, resistors and a double-triode tube is needed.

The condenser values (which are equal) may be increased to lower the frequency. Typical values are .1 mf. for the condensers, 50,000 ohms for the fixed resistor, and 500,000 ohms for the variable one. The latter has an effect on the tone, also. Any double triode may be used.

ROBT. G. WORLEY,
Mansfield, Ohio.

(By proper selection of resistor and condenser sizes, this type of oscillator may be used to produce super-sonic vibrations for the experimenter in that field.—Editor)

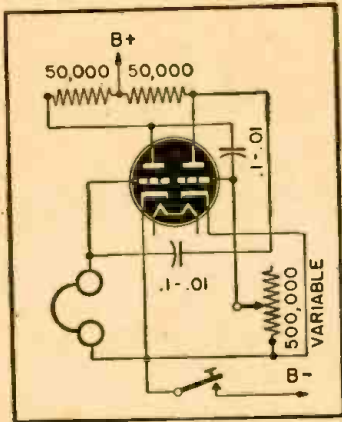

HIGH-OHM SCALES

A meter reading 0-1 MA is suitable for measurement of resistance up to about 100,000 ohms. This range can be multiplied by 30 (readings up to 3 megs) by the use of two small 67½ volt B batteries made for camera-type radios.

The added resistor (134,500 ohms) may be made by filing down a carbon 100,000 ohm, or may be built up from two or more resistors. It is also possible to use a variable resistor in series with a fixed one to total this value.

S/SGT. EARL T. HARTLINE,
San Luis Obispo, Calif.

Any ohmmeter's range may be extended by this method. The resistor must be large enough to keep current to a safe value.

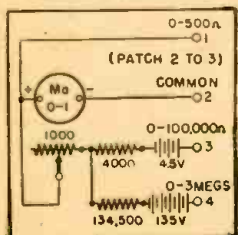

circuits. Hook-ups which show no advance on or advantages *Radio-Craft* welcomes new and original radio or electronic over previously published circuits are not interesting to us. Send in your latest hook-ups—*Radio-Craft* will extend a one-year subscription for each one accepted. Pencil diagrams—with short descriptions of the circuit—will be acceptable, but must be clearly drawn on a good-sized sheet of paper.

FLUORESCENT LIGHT

The greater part of the expense of fluorescence lighting is due to the auxiliary apparatus needed. I have been able to set up a complete system using the following hookup.

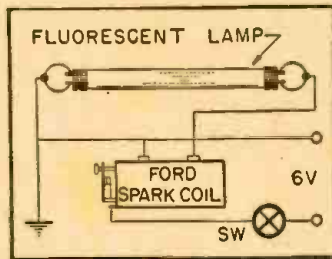

Using this system, fluorescent lighting does not depend on access to 115-volt lines, which are not to be found in many rural districts. An ordinary 6-volt storage battery is sufficient. Either a car battery or "A" battery eliminator may be used, together with a spark coil.

PAUL MITNAUL,
Princeton, N. J.

A "COMPARATOR"

A condenser tester sent in by E. Menzel appeared in the August "Try This One" column. This works very well and I have added another feature to it.

By adding a bank of known condensers, any one of which may be switched into the circuit, it is possible to directly compare with the unknown. When the two neon bulbs are of equal brightness, the unknown capacitance is the same as the switched-in standard.

The 1-pole, 2-throw switch changes from A.C. to D.C.

ROGER WILLS,
Birmingham, Michigan.

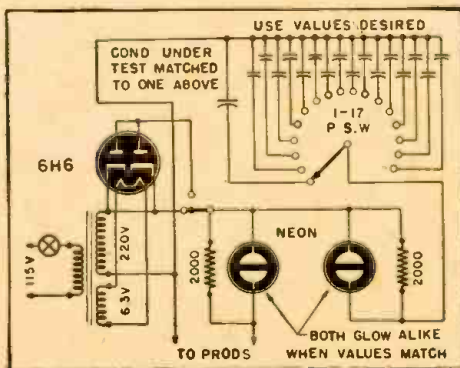

D. C. AMPLIFIER

Here is a diagram of a versatile direct-coupled amplifier for DC. I designed it for use with a rather insensitive photo-cell, but the unusually high gain warrants its use as an all-purpose laboratory amplifier (for DC).

Although two 6J7's and a 6J5 are specified on the diagram, any similar tube types can be used in the amplifier proper without any change in the circuit values. The use of electrically different tubes merely necessitates a different setting of the sensitivity control, the only manual control of the amplifier.

The sensitivity control is a potentiometer which regulates the bias on the input (6J7) tube. About twenty volts, which is several times the cutoff bias of the 6J7 is developed across this potentiometer. This high bias is often necessary in order to compensate for superfluous light striking the photo-electric cell or leakage across the cell. Incidentally, a 900 megohm leakage would cause one volt to be developed across the grid circuit, so watch out for leakage and its chief cause, dampness.

This amplifier is designed for direct voltage amplification, but it can be used as an AC voltmeter as shown in the diagram. When so used the sensitivity

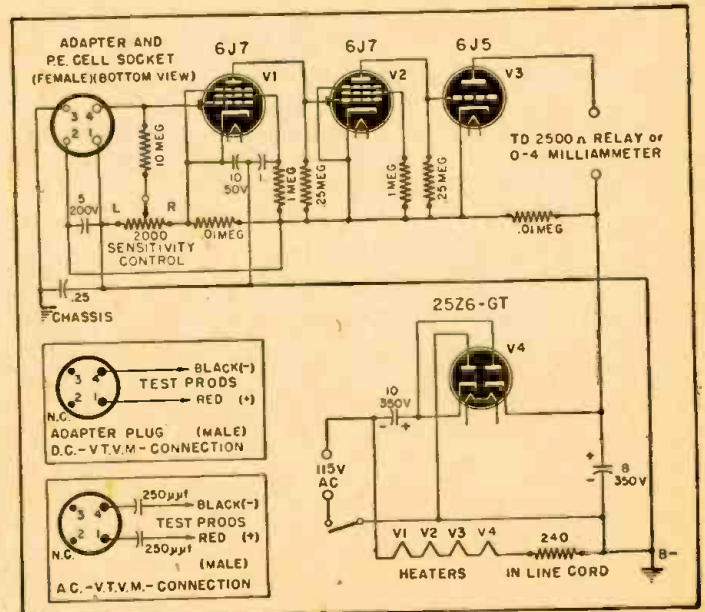

control is turned to the extreme right (zero bias) and the plate current decreases in the 6J5 as the input voltage increases.

The power supply, a 2526GT as a half-wave voltage doubler, is only partially filtered but if your relay should chatter, the 8mf. filter condenser can be increased in capacity.

VERNON J. FOWLER,
Milwaukee, Wis.

PHONO AMPLIFIER

This compact amplifier can be built into a record player, complete with 3" speaker. If AC-DC operation is desired, it is possible

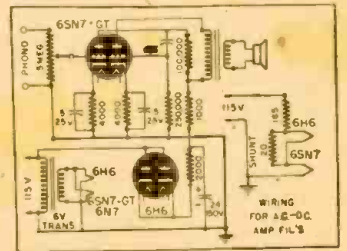

to eliminate the filament transformer, using a series resistor as shown. Grounds shown on diagram are to chassis only, no earth connection being used.

The circuit is very simple and compact, and the whole amplifier can be built into the bottom of a record player. Volume is more than sufficient for most purposes and tone is excellent.

LESTER BALMFORTH,
Toronto, Ont.

(Note—The 6H6 is being greatly overloaded in this circuit, and it would be better to use a small rectifier tube. Space could be saved by using a line-cord resistor and eliminating the filament transformer.—Editor)

SPRAGUE TRADING

A FREE Buy-Exchange-Sell Service for Radio



"T" Is for TROPICALIZED!

... and it means that standard Sprague KOOLOHMS now have the same high degree of humidity protection formerly available only on special order to match exacting military specifications. This new standard construction includes a glazed ceramic outer shell and a new type of end seal. Catalog designations remain the same except that the letter "T" has been added to the old type numbers.

Thus, once again Sprague leads the way! No need for you to study and choose between power wire wound resistor types or coatings. One type of KOOLOHMS, the standard type, does the job—under any climatic condition, anywhere in the world!

WANTED—Signal generator of type suitable for FM radios (postwar period). Prefer range from about 200 Kc.'s to about 100 Mc.'s. Desired for man overseas. Chester O. Smith, 2025 Eye St., N.W., 906, Washington 8, D. C.

WANTED FOR CASH—Mallory vibrapack type VP-554 or VP-552. Also want Stancor 20-N or 10-P transmitter complete with meter, tubes and 160 meter coils. Henry G. Bergen, East Elm St., Goessel, Kans.

URGENTLY NEEDED—Late model tube tester, channelyst, signal generator. Rider's Manuals 6, 7 and 8. All replies answered promptly. S. L. Malone, 2531 Sharon Ave., Dallas 11, Tex.

WANTED—Radio receiver for use in practicing code reception. Tom Mussett, Jr., 1650 W. Lawrence Ave., Springfield, Ill.

URGENTLY NEEDED—Rider's Manuals 1-2-3-4-5. Also want good recording unit. Bob's Radio Service, 988 N. Central St., Knoxville 17, Tenn.

TUBES FOR SALE—5-35; 2-57; 2-41; 2-56; 2-2A7; 1-45; 1-53; 2-59; 6-58; 2-6B7; 3-6Z5; 5-12A5; 1-6D7; 1-27. List over \$48, will sell lot for \$25. These have been in storage. Will trade for good late tube tester, sig. generator, or volt-ohm-meter. Mac Green, 5047 Washington Blvd., Chicago 44, Ill.

WANTED—High-impedance head for RCA "cobra-type" magnetic pick-up. Willoughby W. Moyer, Jr., 19 E. Summit St., Souderton, Pa.

FOR SALE—N.R.I. course complete. R. H. Safford, 3104 Filiser St., Greenmont Village, Dayton 10, O.

WANTED—Hallcrafters Sky Champion or Sky Buddy com. receiver in good condition. Tech. Sgt. William A. Greene, 6274887, Squadron O, L.C.A.A.F., Lake Charles, La.

NOTICE!—When sending in your FREE Trading Post advertisement please type or write distinctly! Mistakes have occasionally appeared because of illegible writing—and a number of advertisements have had to be omitted entirely. We want to help you—please make it easy for us to do so!

SWAP OR SELL—Japanese Wheatstone bridge with meter, good condition, calibrated in English and Japanese. Range 0.01 to 99.99 ohms. Want light plant, portable all-wave set, or test eqpt. Pvt. Julius Skinder, % P.M., San Francisco, Calif.

WANTED—Superior dynamometer with the 2 1/2" double jeweled meter. George Baum, Hagerman, N. M.

WANTED—Power amplifier 18 to 30 watts, 2A3 or 6L6 output, 500 ohm output connection. Describe. Also want RCA-Victor K-130 radio or combination radio-phonograph U-300, U-301, or U-302. Earl H. Swen, Gilby, N. D.

WANTED FOR CASH—RCA or similar std. make television-FM receiver, complete or adapter. Jensen H.F. speaker 15" preferably in bass reflex cabinet. Also Hallcrafters S-27 and Skyrider 32. Albert Bakanz, Colesville Manor, Bethlehem 3, Penna.

FOR SALE OR TRADE—G-E table radio with 50L6, 35Z5, 12SA7, 128Q7, 12B8 tubes, A-1 condition; also Emerson No. 259 port. like new with bat. eliminator for A.C.-D.C. Want test instruments, field coil 2" diam., 1" high, % magnetic pole, or speaker 8, 10, 12, 14", 1000 ohms field with output transformer for 8V6 output tube. Leroy Grikgs, 205 Windmill Lane, Southampton, L. I., N. Y.

FOR SALE—Four No. 301 Weston DC ammeters. Two have range 0-1.5 amps., and two are 0-25 amps. Earl L. Hassler, 2320 N. Youngs Blvd., Oklahoma City 7, Okla.

WANTED—Tubes, test equipment, or what have you? Hunts Radio Shop, 1981 Curtis St., West Roxbury, Mass.

TEST EQPT. WANTED—Will trade Argoflex Reflex, etc. E. Schmitka, 1481 Shakespear Ave., Apt. 4E, Bronx, New York 52, N. Y.

WANTED—Combination recorder and playback unit, preferably G.I., slow or dual speed. Howard Bokovoy, Galen Radio Service, Deer Lodge, Mont.

WANTED—117L7M7, 117Z6 tubes (two of each). Have the following to trade (two each): 3Q5; 1T4; 1R5; 1S4; 3A4; 35Z5; or what do you need? New tubes in cartons—want new tubes in return. Cardon City Radio & Supply, Richard Blair, 710 Clark St., Missoula, Mont.

WANTED—Voloymyst. Have VOM's and a 5- and 10-meter converter. A. M. Stump, 311 Marathon Ave., Dayton, O.

WANTED—Sky Buddy ECL or similar com. receiver. Describe fully. Cash. Kenneth Loewen, Box 463, Hillsboro, Kans.

TUBES WANTED—2-35Z5; 2-12A7; 3-6C6; 2-25Z5; 1-1H5; 1-35L6. Ephraim P. Taylor, 108th Ave. N.E., Wg. C 1345, Kirkland, Wash.

WANTED—Radio tester made for N.R.I. by Triplett (Model 1175A). All-wave, all-purpose tester. Cash. Wilson Radio Service, R. No. 1, Box 120, Lynch's Station, Va.

WANTED FOR CASH—RCA-Rider channelyst. Badly needed. Goodway Repair Service, 810 Belvedere Road, West Palm Beach, Fla.

FOR SALE—Superior channel analyzer, excellent condition. Replaced RF tube for greater sensitivity. \$30, 700 tubes incl. lots of good numbers. Will sell all. Write for list. Luekey's Radio, 117 Lafayette St., Bend, Ore.

WANTED FOR CASH—Good tube tester. Send full details. N. C. Reynolds, 3352 Collier St., Indianapolis 3, Ind.

WANTED—Late N.R.I. course. Name year issued and cost. L. T. Hussin, 63 Miriam St., Valley Stream, N. Y.

WANTED—6-volt auto battery charger, also 6-volt eliminator. LaBorde Radio Hospital, 1503 1/2 Butler Bldg., East Blvd., Baton Rouge, La.

WANTED—12SA7, 50L6, 35L6, or other tubes, also stable radio photo combination or table radio either A-1 or in need of repairs, also Schick elec. razor, etc. A. Laffeur, 421 E. 22nd St., New York, N. Y.

WANTED—Late model tube tester. Cash. Ray Brown, White Mills, Pa.

FOR SALE—Phileo tube checker No. 050, used but little. Will check any tube ever made. \$45. Will take 35Z5, 35L6, 50L6, and 117Z6 tubes in trade. E. R. Wheeler Radio Service, Union Springs, N. Y.

WANTED—By high school radio class, Vol. I, Rider's Perpetual Trouble Shooter's Manual. Cash. A. L. Shelton, Science Head, Queen Anne High School, Seattle 9, Wash.

WILL TRADE—SX25 complete with matching speaker for good used SX16 complete; or will buy for cash if reasonable; or trade for SX28 and pay difference. Sgt. Charles Spielman, 3501 Porter Ave., El Paso, Texas.

WANTED—Home recording and playback unit. Prefer crystal cutter. Ray S. Hanson, Fertile, Minn.

SEND US YOUR OWN AD TODAY!

For over two years now, the Sprague Trading Post has been helping radio men get the materials they need or dispose of radio materials they do not need. Literally thousands of transactions have been made through this service. Hundreds of servicemen have expressed their sincere appreciation of the help thus rendered.

Send your own ad to us today. Write PLAINLY—hold it to 40 words or less—confine it to radio materials. If acceptable, we'll gladly run it FREE OF CHARGE in the first available issue of one of the five radio magazines wherein the Trading Post appears every month.

HARRY KALKER, Sales Manager.

SPRAGUE PRODUCTS CO., North Adams, Mass.
(Jobbing Sales Organization for Sprague Electric Co.)

SPRAGUE CONDENSERS

KOOLOHM RESISTORS

T.M. REGISTERED U. S. PATENT OFFICE

Obviously, Sprague cannot assume any responsibility, or guarantee goods, services, etc., which might be exchanged through the above advertisements.

RY THIS ONE!

Radio-Craft wants original kinks from its readers, and will award a seven-month subscription for each one published. To be accepted, ideas must be new and useful. Send your pet short-cut or new idea in today!

FLUORESCENT LAMP

About a year ago I wished to install a fluorescent lamp in my office which is lighted by a 110-volt DC plant. When I endeavored to obtain material, all I could buy was the lamps; everything else was frozen. After considerable experimenting I have been able to get very satisfactory operation from the circuit shown.

I do not remember where I got the formula, but it appears that the normal input voltage (DC) multiplied by 24, and divided by the wattage of the bulb, gives the proper ballast resistance. In my case the normal voltage is 115; this multiplied by 24 gives 2760—divided by 20 (wattage) gives 138. I finally found a distributor who had a number of 50-watt resistors of varying resistances, and we found a number rating 144 ohms. The carrying capacity is important, as I burned out one or two 20-watt 150-ohm units, but the 50-watt resistors develop very little heat.

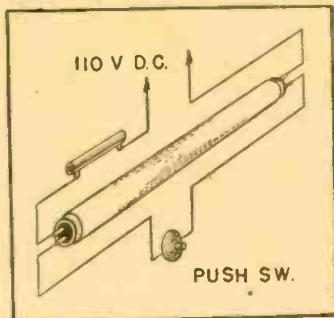

For starting I use an ordinary push button switch. I have a pull-chain switch on the power line socket. To start the light I pull the chain switch, push the button switch until the electrodes at both ends of the bulb glow, then release the button. This requires a little practice to know just the right moment to release.

This method is practicable only with 15- and 20-watt lamps, using from 135 to 150 ohms on the 20-watt, and from 190 to 200 on the 15-watt. It has worked very well for more than a year, and the only blackening of the lamp is about an inch on each end, all of which was caused during the experimental period. I believe that I obtain the same illumination from a 20-watt fluorescent as from a 60-watt incandescent, and with less glare.

HERBERT S. RUTHERFORD,
Eriksdale, Manitoba.

NOVEL FUSE CLIPS

It is sometimes desirable, in a radio set or especially in measuring instruments, to use fuses of the cartridge type to protect the apparatus from damage due to short circuit, overload or other causes.

In some cases there is not sufficient space for the usual fuse mounting. It will be found that the grid clips, sold for use on metal tubes, will fit perfectly on the caps of these small cartridge fuses and take practically no space.

NEW ZEALAND "RADIOGRAM",
Wellington, N. Z.

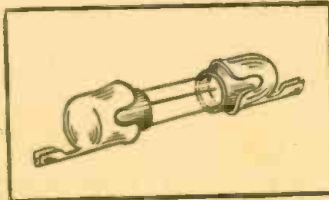

EFFICIENT COIL TAPS

Here is a suggestion for a useful kink in tapping homemade coils. One end of a piece of heavy (No. 14 or 16) copper wire is flattened out with a hammer on an iron block. When winding the coil, the insulation is scraped at the desired point, the wire cleaned and sandpapered, and the flattened wire end crimped tightly around it and soldered, using as little solder as possible.

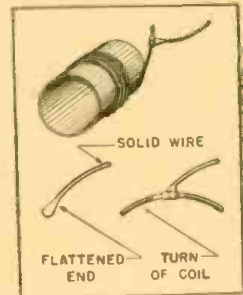

This method of connection makes a solid joint which takes up very little space and therefore does not throw the winding out of shape. It also makes very neat joints in bus-bar wiring.

RALPH C. LIPPERT,
Chicago, Illinois.

ADDING HEADPHONES

A simple connection for the addition of headphones to a modern radio is the following: only a 10,000 ohm potentiometer, a blocking condenser and a switch are required.

Fig. 1 shows the method for a single tube output; Fig. 2 for a push-pull stage. An additional switch serves to disconnect the speaker when phones alone are desired.

B. E. SHELBY,
State Sanatorium, Ark.

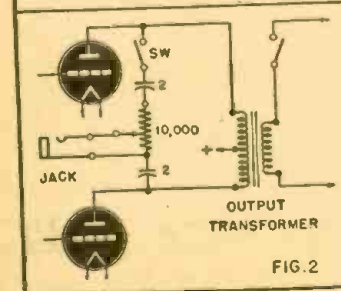
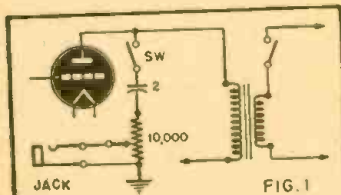

LENS FOR PILOT LAMP

Here is a use for a burned out flash-light bulb of the fused-in lens type now commonly used in the small sizes. Scratch a line around the glass with a glass-cutter or broken edge of a file, countersink a hole in the panel big enough to hold it, and fasten with coil cement.

The whole idea may be seen very clearly from the drawing. No ADDRESS.

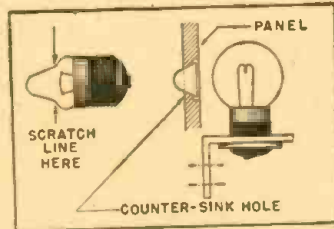

SALVAGING CHASSES

If you are an experimenter who uses the same old steel chasses over and over again for different hookups, you will soon find that they begin to look like buckshot targets.

These holes (up to a quarter-inch) can be plugged with solder so neatly that you can't even find where they were! Put soldering paste on the inside of the hole, a flat piece of metal or wood underneath, and flow solder into the hole. Finally, work over the top of the hole with a file or steel wool.

A. H. MEHNER,
Port Angeles, Wash.

INSERTOR

I find this gadget very handy around my radio shop when shunting condensers or resistors around suspected "open" ones.

It was made with two wood dowels and a "Tinkertoy" wood wheel. Simply wrap the pigtails of a good condenser (or resistor) tightly around point A. Different condensers or resistors can be fastened on or taken off quickly.

W. S. MOORE,
Allen, Oklahoma.

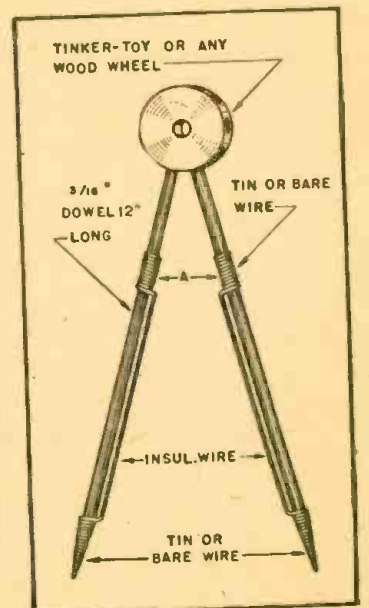

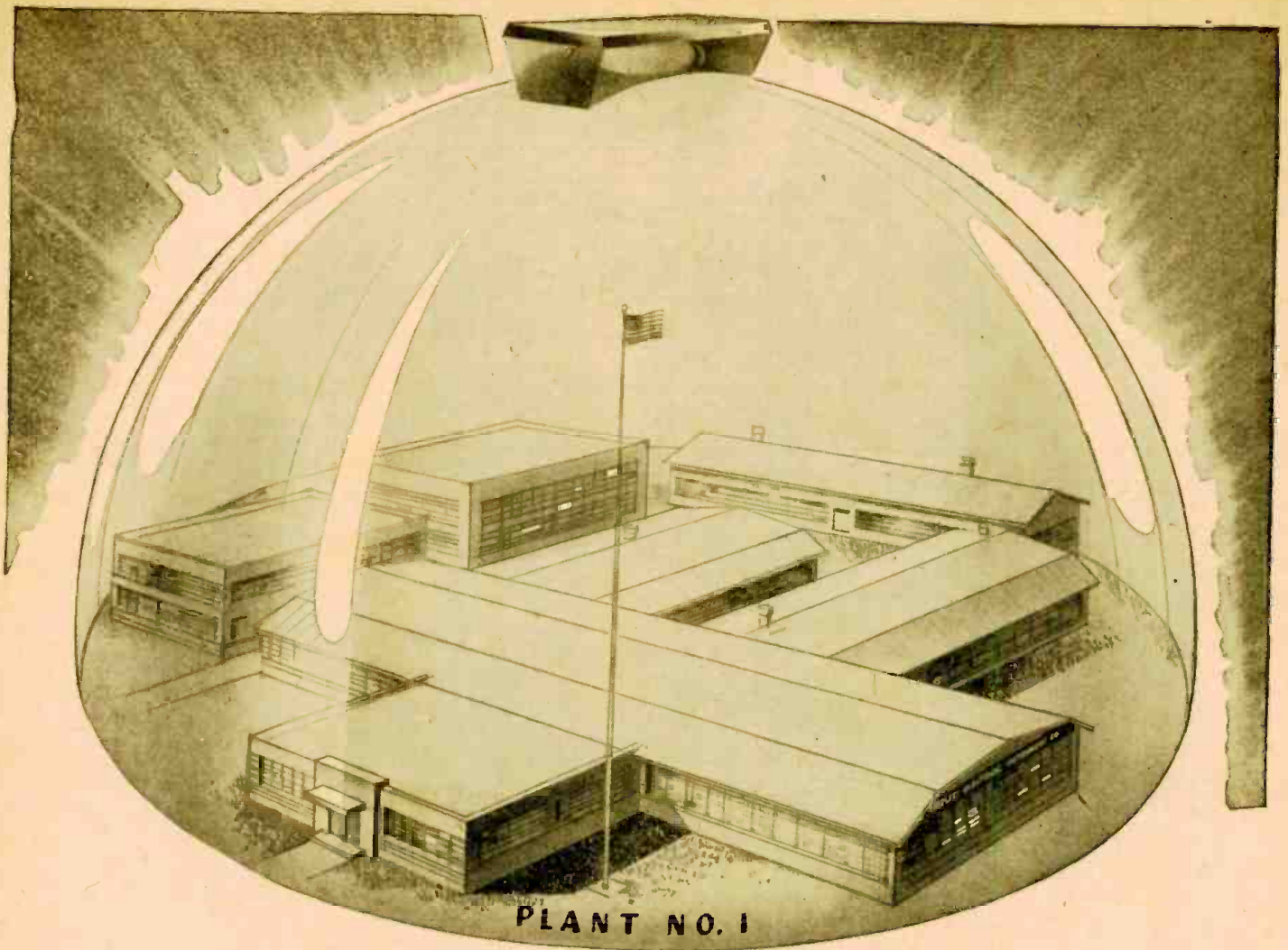

" DUSTLESSTOWN, OHIO "

● It's the little things that loom biggest in the manufacture of delicate electrical measuring instruments. Little things like specks of dust or breath condensation can play havoc with accuracy. That's why Triplett Instruments are made in spotless manufacturing departments; why the air is washed clean, de-humidified and

temperature-controlled; why every step in their mass production is protected. As a result Triplett Instruments perform better, last longer and render greater service value.

Extra Care in our work puts Extra Value in your Triplett Instrument.

*Precision first
...to last*



Triplett

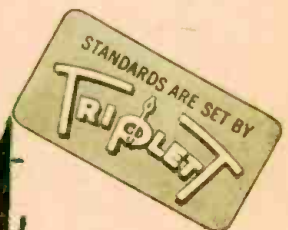

ELECTRICAL INSTRUMENT CO. BLUFFTON, OHIO

THE QUESTION BOX

1D8-GT RECEIVER

? Please draw a diagram for a one-tube receiver using a 1D8-GT, showing all values of circuit components. Desire to use 45 volts on plates and screen and if advisable resistance coupling between triode and pentode sections. If it is practicable desire to use a low-impedance dynamic earphone mounted in the cabinet, as a small speaker. (D.C. resistance of phone is 15 ohms). Please give coil data including number of turns on tickler. Only wish to cover broadcast band. —H.T., Bothell, Wash.

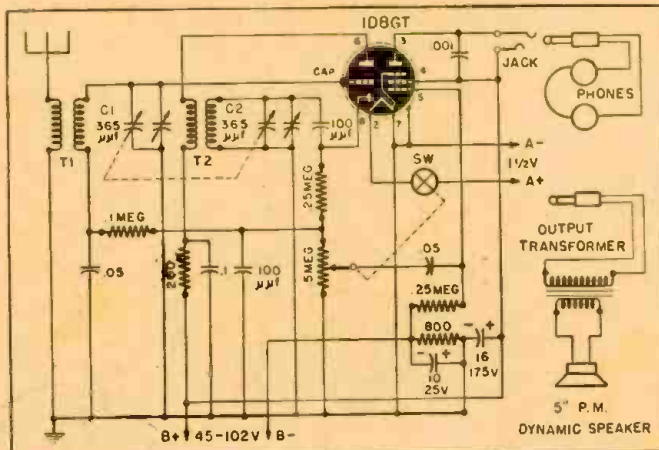

The 3-in-1 receiver is one of the most successful one-tube sets.

A. The diagram printed here-with is that of the "3-in-1" receiver, which originally appeared in the July, 1940 issue of *Radio-Craft*. It can be used at low voltages with correspondingly lower volume and sensitivity. If you wish to use your dynamic earphone it will be necessary to hook it up with an output transformer, as shown for the PM speaker in the diagram. Grid bias is automatic in this set, being controlled by the 800-ohm resistor in the B-negative lead. A suitable coil for your purposes would have a secondary of 80 turns of No. 28 enamel and a primary (antenna coil, tickler) of 20 turns of finer wire, say No. 30 to 32. Both the coils shown in the diagram may be identical, and are wound on standard 1½ inch coil-forms.

By substituting 140-mmfd condensers for the 350-mmfd type shown in the diagram, and using standard plug-in coils, the receiver may be used to cover the short-wave bands. On short wave especially, but to some extent on broadcast, better results will be obtained by using two independently-tuned variable condensers instead of the ganged unit. Extremely careful cutting and trimming of coils is necessary if a ganged condenser is used on short wave, and on the broadcast band greater selectivity is possible if the two circuits are independently tuned.

TRACER QUERIES

? I built the signal tracer described in the June, 1942, issue and would like to ask the following questions:

The R.F. tube 6U7-G (I used a 6D6) oscillated whenever I turned the 0.5-megohm volume control beyond three-quarters of the way up. By connecting a .0005 condenser between the 6D6 plate and cathode I could advance the control all the way without oscillation. Is this practice O.K.?

In the tracer I built the plate

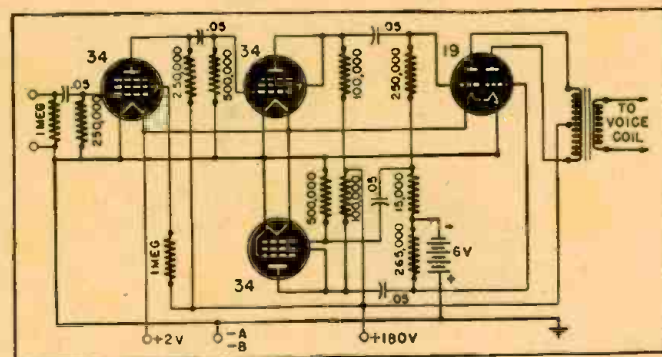

Reasonably large output can be secured with this small amplifier.

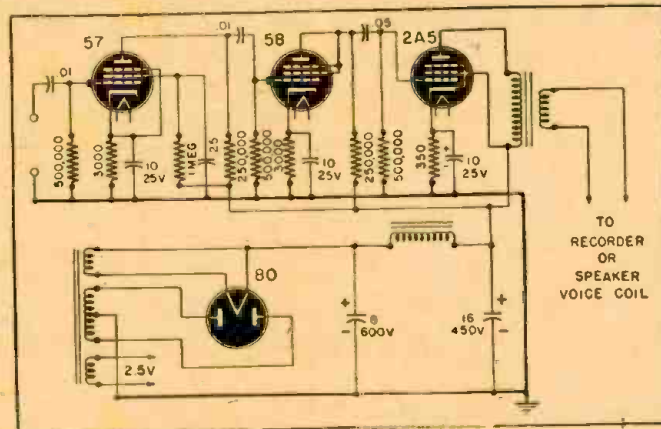

This four-tube amplifier has good quality at low power levels.

and screen resistors of the 6D6 are 100,000 and 500,000 ohms respectively. In another signal tracer shown in the August, 1941, issue, the same tube (6D6) uses only 50,000 and 100,000 ohms respectively. Why such a big difference, and which circuit is best?

In still another tracer shown in the July, 1944 issue, the plate resistor consists of a 50,000- and a 2,000-ohm resistor with a .05 condenser from the junction of the resistors to ground. This circuit is also used in the tracer in the September, 1940, issue. Why

the divided resistor with a condenser to ground? —E.J.R., Riverside, R. I.

A. Use of a small condenser from plate to cathode of the tube is satisfactory and is occasionally used in certain receivers. It cuts down the gain, so if you can locate and remove the source of feedback to the 6D6 grid, additional signal will be available. Perhaps some rearrangement or shielding of the 6D6 grid circuit would remedy the trouble.

Value of plate and screen resistors depend on the gain and

frequency range desired. Higher resistance permits greater gain but causes greater R.F. frequency discrimination over certain portions of the band. Signal tracers often use very low plate and screen resistors in order to cover a very wide range of frequencies.

The 50,000-ohm resistor you ask about is the plate load resistor, while the 2,000-ohm resistor and condenser from a decoupling circuit (or resistance-capacity filter). You will find this circuit used in all the better-grade modern amplifiers, both R.F. and A.F. Such a decoupling filter in each plate circuit reduces interaction between stages.

2-VOLT P.A. JOB

? Will you please print a circuit for an amplifier using some of the enclosed list of battery tubes? As much output power as possible is required, without the use of transformer coupling, as class-B and other audio transformers are unobtainable here.—F.B., Innisfail, Alberta.

A. The diagram given here uses tubes which you have. Considerable power is available if 180 volts is used on the output plates, and this high voltage will also help the gain of the other stages.

It is a pity that you cannot obtain the push-pull transformer for the output stage, as with even a class-A transformer the grid-circuit impedance would be much lower, permitting a larger signal to be placed on the grids.

HI-FI AMPLIFIER

? I have an old receiver which uses 2 58's, a 57, a 2A5 and an 80. Can I build this into a high-quality resistance-coupled amplifier which could be used for a record player or other purposes?—T.S., Whiting, Indiana.

A. An amplifier of good quality can be built with your apparatus. Power will be limited, however, to the amount the single 2A5 can handle without distortion. A 56 would work well in place of the 58, should one be available. Your own power and output circuit beginning with the grid of the 2A5, can be used without change, and you will probably find it advisable to build the amplifier in the old receiver cabinet, so these parts can be worked into the circuit without disturbing their present wiring.

A special output transformer will be needed for recording. It should be designed to match the cutter-head impedance.

1	2	3	4
5	6	7	8
9	10	11	12
13	14	15	16

ELECTRONIC Puzzle Square

By

LT. C. K. JOHNSON

In this simple series of problems answer Question 1 by the part number closest to it on the schematic below. The answer to Question 1 goes in Square 1, etc. When finished, the rows, columns, and diagonals will total the type number of a variable- μ tube which has a two-volt filament.

1. The frequency is controlled by this part.
2. This component operates class-A.
3. An oscillator circuit is built around this component.
4. Antenna coupling is varied by this control.
5. This component is called a class-C amplifier.
6. Modulation percentage is controlled by this device.
7. This device varies grid bias.
8. This component keeps B+ off the amplifier grid.
9. This unit has an iron core and is in the audio range.
10. Voltage is developed across this part because the D.C. component of plate current flows through it.
11. R.F. is kept on the grid by this part.
12. This is to load the antenna.
13. This unit is hooked in a push-pull circuit.
14. This component prevents the R.F. amplifier from oscillating.
15. This unit is used to tune an LC circuit to some multiple of the plate current frequency.
16. Grid current flows through this part to develop bias.

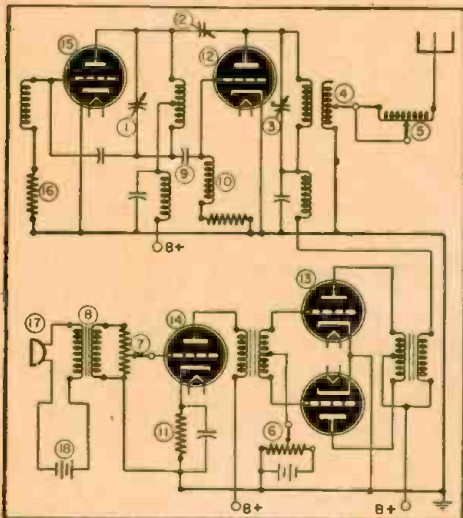

(Please turn to page 311 for answers)

USES FOR THE OA4-G

(Continued from page 288)

this case the lower impedance is dispensed with, so that the starter-anode is normally at approximately the potential of the anode. The tube therefore conducts. When a flame is applied across the two probes, however, the started potential is lowered and the tube de-ionized. An alarm may be caused to sound when the flame is withdrawn or extinguished. A variation of this circuit (Fig. 3a) uses a light-sensitive cell. Normally no action takes place, but light striking the

PORTABLE POWER PROBLEMS

THIS MONTH—BRISTOL PYROMASTER

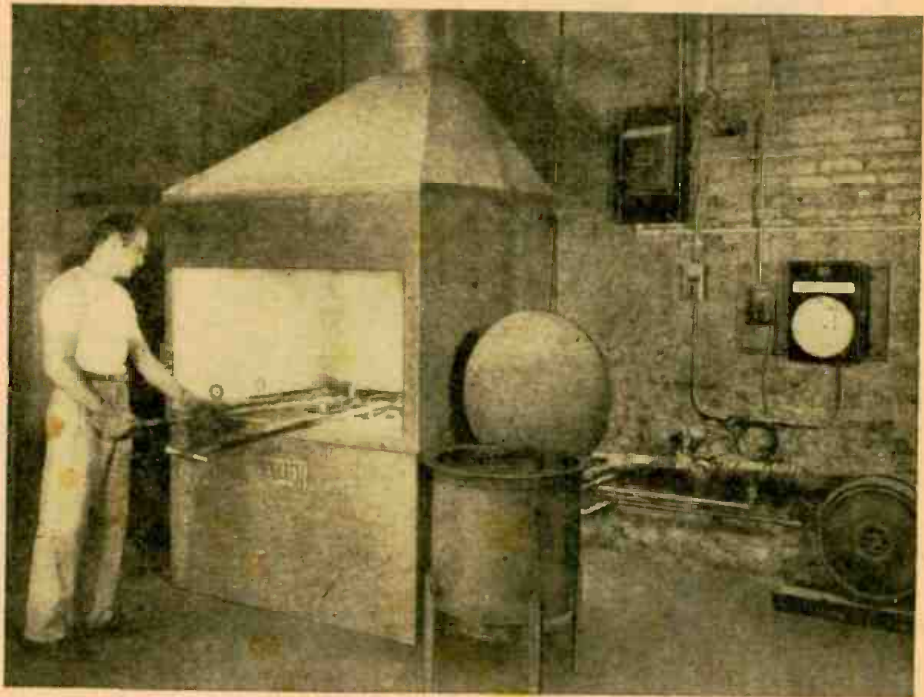

INDUSTRIAL PROCESSES are accurately recorded, indicated and controlled by the Bristol Pyromaster Self-Balancing Potentiometer. In the illustration above, a Pyromaster maintains temperature control of a gas-fired furnace, used for case hardening steel parts.

DIRECT MARKING pen moves instantly and continuously at the rate required to follow temperature variations. A 1½ volt Burgess Battery supplies constant current to the potentiometer circuit. Burgess Industrial Batteries are designed to meet the exacting specifications of special instruments.

Write today about your

specific needs. Free 80-page Engineering Manual on characteristics of dry batteries. Write Dept. C-6, Burgess Battery Company, Freeport, Illinois.



BURGESS BATTERIES

cell partially closes the circuit between starter and anode, raising the potential of the former with respect to cathode. Both circuits—invented and patented by William F. Wolfner, II, of Methuen, Mass.—may be operated directly from the A.C. line.

For operation of OA4-G tube circuits on still smaller impedance changes, the same inventor has designed the circuit of Fig. 4. An impedance change at Z results in a further voltage variation (due to mutual inductance effects) in the starter circuit, to be added to that normally present. For many industrial purposes such great sensitivity is required.

USE AS PHOTOCELL

A Radio-Craft contributor, Robert Melvin of Berkeley, Calif., has found a very novel use for the OA4-G tube. While carrying on experiments with remote controlled systems, it was found that the tube could be used as

a photocell with some success, some tubes being more sensitive in this respect than others. His circuit is shown in Fig. 5. All resistors may be one-half watt.

When the tube is near the point of operation, light striking it initiates discharge and the relay is caused to operate. The 5000-ohm resistor, while not absolutely necessary, was found to add stability. The relay used in this case operated on only one milli-ampere, but such sensitivity is not required, since a comparatively large cathode current flows during breakdown (see tube characteristics above).

Many other applications for this gas-filled triode are possible and the parts required are few. The tube itself is inexpensive; possibly that very point has caused it to be overlooked by some who subconsciously felt that higher-priced "gas-tubes" are necessary for the results just described.

LARGEST STOCKS CENTRALIZED SERVICE

FREE
Complete
Up-to-date
BUYING
GUIDE



Everything
in **RADIO and**
ELECTRONICS

REPAIR and
REPLACEMENT
PARTS
AVAILABLE
without priority

SAVE TIME
CALL ALLIED FIRST!

Thousands use Allied's nation-wide service. Centralized here are today's largest and most complete stocks under one roof. Over 10,000 items from all leading manufacturers . . . for the Armed Forces, Radio Training, Laboratories, Industry and Service Replacements. Our experienced staff simplifies procurement—expedites delivery. Call ALLIED first . . . for everything!

Write, Wire, or Phone Haymarket 6800

6 Radio Books for 75c

- | | | | |
|---|-----|---|-----|
| Dictionary of Radio Terms.
No. 37-751 | 10c | Radio Data Handbook.
No. 37-754 | 25c |
| Radio Circuit Handbook.
No. 37-753 | 10c | Radio Builders Handbook.
No. 37-750 | 10c |
| Radio Formulas & Data Book.
No. 37-752 | 10c | Simplified Radio Servicing.
No. 37-755 | 10c |
| All Six Books No. 37-799 | | 75c | |
- Write for Quantity Prices*



ALLIED RADIO CORP., Dept. 2-B-5
833 W. Jackson Blvd., Chicago, Ill.

Please send following books (.....c enclosed)
 FREE 37-750 37-752 37-754
 Buying 37-751 37-753 37-755
 Guide No. 37-799 (All Six Books)

Name.....
 Address.....
 City..... State.....

ALLIED RADIO

CAPACITY BRIDGES

(Continued from page 275)

The variable 2500 ohm resistor in series with the 1 mfd. condenser will assist in obtaining a balance. This resistor is also used for the measurement of power factor. It should be calibrated in power factor-per cent. The method of doing so is as follows: Temporarily short-circuit the 1 mfd. condenser and balance the 2500 ohm variable resistor against fixed standards of resistance placed in the C and R terminals. These standards will range from approximately 80 ohms for 2% to 2400 ohms for 60%.

When testing electrolytic condensers for leakage care must be taken to connect them for correct polarity, although accuracy does not warrant it, and the condenser will certainly not be harmed by the brief application of incorrect voltage whilst it is under test.

The leakage test may be used for detecting leakage anywhere, but its main purpose in this unit is for detecting leakage in condensers. The neon lamp employed should have a striking voltage of about 80 volts as the voltage available is only 100 volts. When a condenser is connected across the leakage terminals the neon lamp will flash momentarily, due to charging. If the condenser is good it may take a short time until the next flash. A leaky condenser will flash every second or so, and one that is really in bad shape will show a continuous light. Care must be exercised when applying the above principles to electrolytic condensers, as they always have a certain degree of leakage.

The power factor of a condenser may be taken as that fraction of the total alternating current through the condenser which is in phase with the applied voltage, and so causes the generation of heat in the condenser. Thus it will be observed that as heat is the factor which limits the amount of ripple which the condenser can safely withstand, it is desirable to have a condenser with a low power factor for smoothing purposes. In radio circuits employed in commercial work, this ripple current may be up to 150 milliamperes R.M.S.

Discretion must be exercised when a smoothing condenser is measured for power factor, as it does not always follow that the condenser with the lower power factor is the better. The writer has come across many instances when the condenser with the highest power factor has been superior in all respects including smoothing efficiency. In smoothing condensers, providing the power factor does not exceed 30%, negligible loss of smoothing efficiency is likely to be encountered.

The rectifier circuit used in the bridge introduces some novel details. The tube employed is that versatile diode, the 6H6, which has gained so much popularity for use in detection, AVC systems, electron voltmeters, etc., and is employed in this bridge in the capacity of a low voltage half-wave rectifier. One of the main reasons for its inclusion was the limited space available for construction and that a metal rectifier was unobtainable. Secondly, the heater has the same rating as the 6E5. Thus the filament transformer winding serves both. Last but not least, the current per anode of the 6H6 is 4 milliamperes. All that is required is the current drawn by the 6E5 target and triode plate current—approximately 1.5 milliamperes at 100 volts—so the 6H6 is not overloaded by this small consumption. On actual tests the total consumption of the unit was 1.6 milliamperes. The instrument is rarely used for long periods and no undue heating effects should take place. During the testing of the instrument, it was allowed to run for over two hours at full load, with no signs of overheating. One point of caution, if this rectifier circuit is to be used in other experimental outfits, be certain that the current drawn is well within the limits of the tube, and that the R.M.S. value per anode does not exceed 117 volts.

The voltage supplied to the 6E5 target is approximately 115 volts, which is sufficient for efficient operation.

Variations in the design of the power supply can readily be adapted to suit the

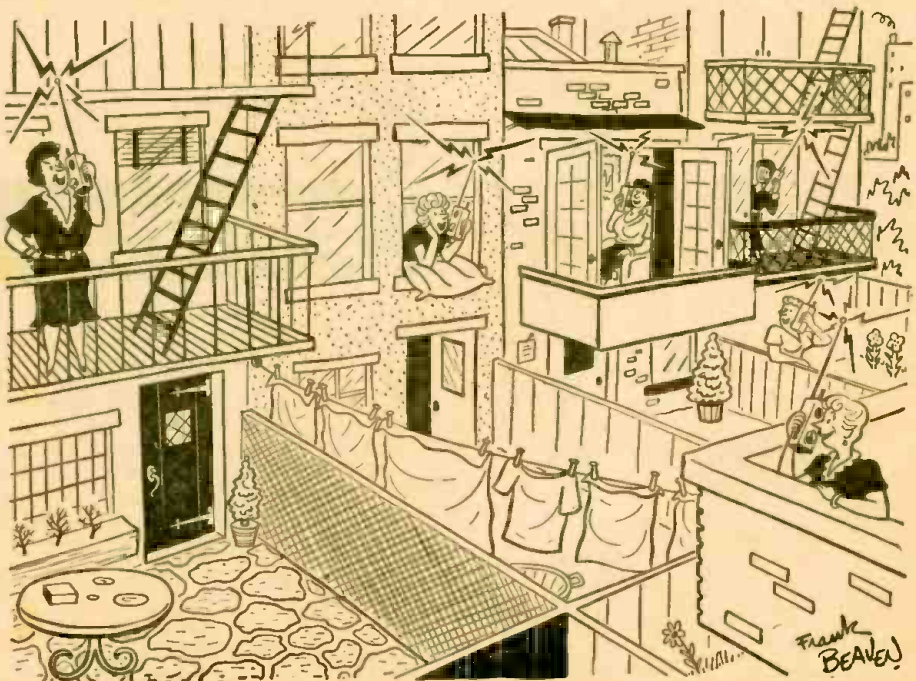

Suggested by: Gus Glaser, Jr., New York City

"Backyard Conference"

components the reader possesses. For instance, if a transformer with only a 50-volt winding is available, there is no reason why the constructor should not use it for the bridge section, and employ a half-wave series line unit, with the 6H6 and 6E5 heaters in series with a line cord. This arrangement was tested and worked satisfactorily.

A double-pole double-throw toggle switch is incorporated in the instrument, so that scales calibrated on resistance will also hold good for capacity. By employing this switch, the action of the bridge is reversed for capacity measurements, thus enabling a single scale reading from .01 to 100 to be employed for both. All that is necessary in the operation is to place the switch in the correct position when measuring a resistor or a capacitor. The values of the standards chosen are in multiples of 10. Thus the reading on the scale is multiplied by the value of the range on which the measurement has been made. For instance, if a resistor is being measured on the 100-ohm range and a reading of .4 is obtained, then the value of the resistor is .4 times 100, which is of course, 40 ohms.

The resistance R1—of value 1000 ohms 3 watts—in series with the transformer and potentiometer automatically graduates the bridge voltage to suit the impedance being measured. It will be seen that for resistances of high value and condensers of small value, the full 50 volts is available and for low impedances which at a voltage of 50 would pass too much current both for themselves and the transformer, the voltage falls to a suitable value. Even if the test prods are accidentally shorted, no harm will ensue. It will be noted that 3 megohms is the value employed for the grid-cathode resistor of the 6E5 tube, but this value is not a hard-and-fast one, as during test operations of the instrument it worked successfully with values between 2 and 5 megohms. If there is any sign of the 6E5 overloading an increase in this resistor is advised. Overloading is indicated when in place of a shadow a patch of extreme brightness appears. The resistor in the power supply, R2, of 10,000 ohms 2 watts, may be increased or decreased to obtain the correct potentials at the 6E5 target and anode, which in this case is 100 volts. The bridge may also be used to supply a variable 60-cycle signal up to 50 volts.

One final point in connection with the various bridges described. *The accuracy of the bridge will depend on the accuracy of the standards employed*, and resistors and capacitors of close tolerance should be obtained. The accuracy of the last described bridge is between 1% and 5% depending on tolerance of standards. For all practical arrangements this will be accurate enough for servicemen, amateurs and experimenters. If higher standards of accuracy are required, the next item is an elaborate laboratory bridge with accuracy to 1/2%.

SCIENCE STRIDES IN '44

The ten most important advances in science made during 1944 as picked by Watson Davis, director of Science Service, are:

1. Application of jet-propulsion to aircraft.
2. Use of robot bombs and self-propelled large rockets in warfare.
3. Successful widespread use of the chemical DDT as an insecticide, particularly against the carriers of malaria and typhus.
4. Use of the mold chemical, penicillin, in the successful treatment of a wide variety of diseases.

RIDER VOLUME XIV COVERS 1941-42 RECEIVERS

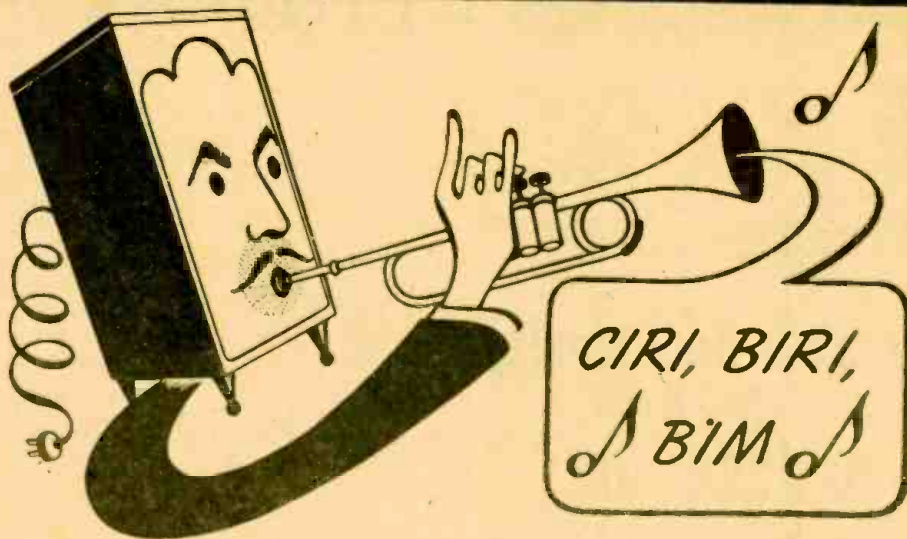

That's me back in '41 when I was new. Among the first programs I carried was one of a new band, headed by a Harry James. The kids said he played "divinely." I played pretty well myself then, too, but I've worked so many long steady hours in the past four years I should be in a service shop this very minute. A lot of my contemporaries are. It's a lucky thing for us—and radio

servicemen—that Rider Manual Vol. XIV is now out for they make the diagnosis and correction of our ills easy, fast and accurate. We radios have our war job and we want to be working at it with as few interruptions as necessary. When you order Rider Manual Vol. XIV from your jobber, please be patient if he is out of it right then. He and the Rider folks will get your volume to you as fast as WPB limitations permit.

RIDER MANUALS (14 VOLUMES)	
Volumes XIV to VII . . .	12.50 each volume
Volume VI	9.50
Abridged Manuals I to V (1 vol.)	15.00
Automatic Record Changers and Recorders	7.50
OTHER RIDER BOOKS YOU NEED	
The Cathode Ray Tube at Work Accepted authority on subject	4.00
Frequency Modulation Gives principles of FM radio	2.00
Servicing by Signal Tracing Basic Method of radio servicing	4.00
Servicing Superheterodynes	2.00

The Meter at Work An elementary text on meters	2.00
The Oscillator at Work How to use, test and repair	2.50
Vacuum Tube Voltmeters Both theory and practice	2.50
Automatic Frequency Control Systems—also automatic tuning systems	1.75
A.C. Calculation Charts Two to five times as fast as slide rule	7.50
Hour-A-Day-with-Rider Series—	
On "Alternating Currents in Radio Receivers"—	
On "Resonance & Alignment"—	
On "Automatic Volume Control"—	
On "D.C. Voltage Distribution"	1.25 each

JOHN F. RIDER PUBLISHER, INC. 404 FOURTH AVE., N.Y. 16, N.Y.
Export Division: Rocke-International Corp. 13 E. 40th Street New York City
Cable: ARLAB

RIDER MANUALS *are complete*
IN 14 VOLUMES

5. Chemical impregnation of wood that converts soft woods into hard.

6. The use of the silicone family of synthetic resins in waterproofing and insulating various materials.

7. The splitting of human blood seven ways to give albumin for shock, gamma globulin for measles preventive, fibrin foam and plastic for use in surgery, fibrinogen for use with thrombin for cementing skin grafts, globulin for blood typing and red cells for wound healing.

8. Building of a mathematical robot, an automatic sequence control calculator, to speed intricate calculations needed for the war and scientific research.

9. Use of ultraviolet light and triethylene glycol in air to reduce the spread of airborne diseases.

10. The entry into the war of the world's largest bomber, the B-29 Superfortress.

AN ELECTRONIC ACCOMPANIST

(Continued from page 284)

As a further example, a single note near the center of the keyboard would cause oscillation by both the soprano and bass, short-circuit the other two oscillators and each speaker would sound the same note. This prevents any speaker from remaining silent at any time.

This organ should prove of great value in training of choirs and musical groups. Since each section hears its own part predominantly, less rehearsal and training is required and the final rendition is greatly enhanced. Congregations and audiences are thus enabled easily and correctly to follow assigned parts.

Train Now for a
Secure Future in
Radio-Electronics
Engineering



There's No Priority On A BETTER JOB!

Add Technical Training to Your
Practical Experience—THEN Get That
BETTER Radio Job You Want!

CREI home-study training in practical radio engineering enables you to go after—and get the better jobs that mean something in radio. There's no priority on success—but the better jobs are "rationed" to those men who have the necessary technical ability.

Jobs that provide security—jobs that will mean something long after "tomorrow" has come and gone—must be won and held on ability. The men who will retain the important radio-electronics engineering positions after the war is over are those men whose positions are essential—whose abilities are specialized.

CREI home-study courses in Practical Radio-Electronics Engineering have been studied by more than 10,000 professional radiomen. In our proved course of home-study training, you learn not only *how* . . . but *why*! Easy-to-read-and-understand lessons are provided you well in advance, and each student has his personal instructor who corrects, criticizes and offers suggestions on each lesson examination.

Don't say YOU haven't the time. CREI courses are designed to be studied in the most crowded schedules. You can study a few hours a week without interfering with your present work. So, write for all the facts now—for this is the time to make sure that your preparation for post-war success shall not be "too little, too late!"

● WRITE FOR NEW, FREE 36-PAGE BOOKLET

If you have had professional or amateur radio experience and want to make more money—let us help you qualify for a better radio job. TELL US ABOUT YOURSELF, so we can intelligently plan a course best suited for your needs.—PLEASE STATE BRIEFLY YOUR BACKGROUND OF EXPERIENCE, EDUCATION AND PRESENT POSITION.



CAPITOL RADIO ENGINEERING INSTITUTE

Home Study Courses in Practical Radio-Electronics Engineering for Professional Self-Improvement

Dept. RC-2, 3224 — 16th St., N. W.
WASHINGTON 10, D. C.

Contractors to U.S. Navy—U.S. Coast Guard
—Canadian Broadcasting Corp.—Producers of
Well-trained Technical Radiomen for Industry.

Progress in Invention

Conducted by I. QUEEN

GAIN CONTROL

Patent No. 2,358,325

THIS circuit, invented by George W. Fyler, Stratford, Conn., is suitable for ultra-high frequencies involving band widths such as those used in television. In ordinary amplifiers it is found that changing the grid bias (for gain control) varies the input capacitance by one or two MMF. A more negative grid decreases the capacitance and results in better low frequency response. Fig. 1 shows (a) normal bias, (b) slightly neg. bias and (c) still higher bias.

It is also found that variation of screen potential results in the opposite effect. Fig. 2 shows (a) normal, (b) and (c) progressively decreasing screen voltage. Fig. 3 provides a circuit where one effect balances the other. As the tap (t) on the voltage divider moves to the left, the screen voltage decreases, resulting in a larger shunting effect of R. The increase of current through the bleeder circuit simultaneously increases grid bias. The final result is shown in Fig. 4 for (a) normal gain, (b) less gain (c) minimum gain.

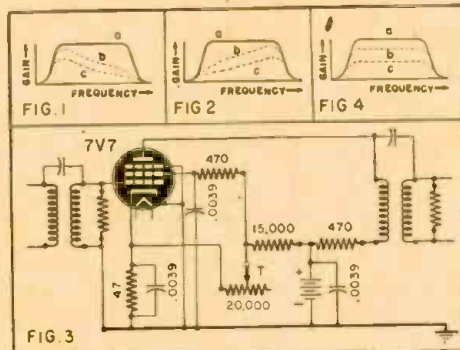

ELECTRONIC ALARM

Patent No. 2,355,752

THIS simple, efficient means of indicating changes in an external load is the invention of Joseph T. Repking, East Chicago, Ill.

The load circuit is completed through the filament of an ordinary rectifier tube, such as an 80. A shunt by-passes such a proportion of the current that the tube filament receives its normal amount, and a high- and low-current relay is connected in its plate circuit.

If the current in the external circuit decreases greatly, for example by the burning out of a number of lamps, current flow through the power rectifier filament decreases, reducing the emission. The underload relay contact falls back, ringing the alarm. Should abnormal input voltage, or a short in the load, increase the filament current, the increased emission sends more current through the tube plate circuit, operating the overload relay, opening the circuit and again actuating the alarm.

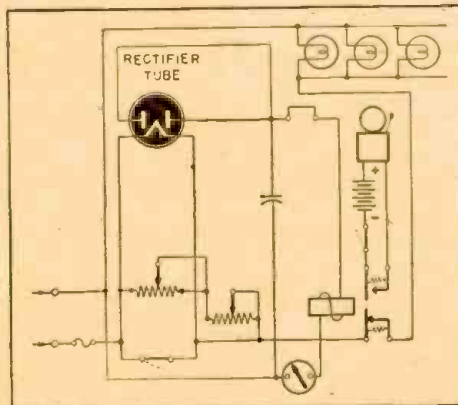

6L6 AMPLIFIER CIRCUIT

Patent No. 2,358,148

USING the slightly unconventional audio amplifier circuit shown, it is found that tube life can be greatly increased and better efficiency obtained with somewhat greater output.

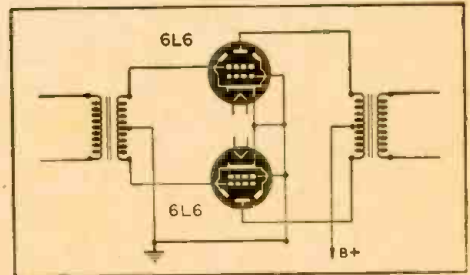

The screens are grounded so that very little plate current ordinarily flows. This eliminates the need for grid bias, and up to twice normal plate voltages may be used. The input capacitance is also greatly lowered, so that a greater impedance in the grid circuit may be used, as compared with a normal class-B circuit.

The general operating characteristics are similar to those obtained in the operation of class-A triodes, according to the inventors, Wilbert H. Cook of New York City and Henry C. Dalrymple of West Orange, New Jersey.

FREQUENCY METER

Patent No. 2,358,127

AN unknown frequency may be measured by its beat note with a known frequency. To adjust the first to equal the latter, it is therefore necessary to obtain zero beat. Very low frequencies are inaudible, however, so that an approximation only is possible. With this new circuit, invented by Henry V. Hermansen, Baltimore, exact synchronism may be made through the use of a 6E5 or similar tuning eye tube.

A crystal of known frequency is used in a Pierce circuit between grid and plate. The unknown frequency is adjusted until the fluctuations of the shadow sector of the 6E5 cease, at which point exact synchronism exists.

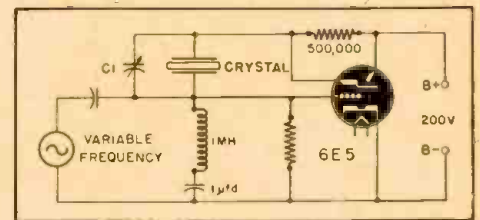

Improved AM service as a result of the increase in FM stations was seen by Paul Chamberlin of General Electric, in a recent address. The expansion of FM, he said, would bring about a decrease in the number of AM stations, with consequent reduction of interference and opportunities for increased power. Future AM stations of 500 or even 1,000 kilowatts might provide service over greater distances than today.

Future scientists will be able to read a person's mind whether he wants them to or not, declares Dr. Edgar Douglas Adrian of Trinity College, Cambridge. The reading will be done directly from the brainwaves recorded on an encephalograph. Such electrical pictures of actual thought will be possible only after the young men come back from war and start research again.

CROSS-OVER NETWORKS

(Continued from page 288)

equal. This circuit is somewhat similar to the basic type in Fig. 1, but here we have added capacitive and inductive elements in series with tweeter and woofer, thus enhancing the sharpness of cross-over and the frequency discriminating properties of the complex network. The basic action remains the same, series inductance cutting down the highs, and favoring lows, series capacitance favoring highs, shunt capacitance cutting highs, shunt inductance raising highs.

Another form of network is shown in Fig. 4. It is apparent that here the series combination of L and C across the input may resonate at a definite frequency. When that happens, the voltage across the coil in shunt with the tweeter will rise to a peak value, which may be undesirable. Hills and valleys in the response of the speakers are not wanted, but a flat response is often desired. A great deal depends on other design factors. For example, if the speaker cabinet is of such design that the lows are not properly reproduced the peak may be permissible or even desirable in the case of the woofer and the series resonant circuit associated with it. An expansion of this network, quite simple in nature, involves adding an additional inductive element, as indicated in Fig. 5. An additional capacitive element is added in series with the tweeter.

The division of frequencies is not complicated nor difficult to arrive at, but from a practical viewpoint there may be complications in properly distributing the power. If too much power is fed to a tweeter it will overload. There is also the problem of taking into account the efficiency of the speakers in converting electrical signal power into acoustical power. This efficiency may vary considerably for different types of speakers.

A circuit that can be used on a practical basis is that of Fig. 6. Considerable flexibility is afforded by the design. The amount of power fed to the speakers can be controlled by selection of the turns ratios on the transformers. (See "Matching Loudspeakers" *Radio-Craft*, Dec. 1944.) Further, in the case of the tweeter, the power can be controlled by selection of the series capacitive element C5 if necessary. Usually, C5 is made large enough so that it offers little opposition to high frequency currents and the amount of tweeter power is then controlled by T2 and C6.

References:

RADIO ENGINEER'S HANDBOOK, Terman, 1st ed., p. 249.

LOUDSPEAKER DIVIDING NETWORKS, Hilliard, *Electronics*, January 1941, p. 26.

DIVIDING NETWORKS FOR TWO WAY HORN SYSTEMS, *Communications*, June 1942, p. 14.

The RID (Radio Intelligence Division of the Federal Communications Commission) has investigated 9,000 cases of alleged subversive stations in this country and elsewhere. Nearly 400 such stations have been located and put out of commission since July 1, 1940. More than 200 Axis spies have been rounded up in South America with the help of information supplied by the RID.

The post-war newspaper may be printed in your own home and delivered to you at breakfast with the latest news up to the hour, according to facsimile experts. Even before the war, facsimile receivers were obtainable at about \$75.

Ted McElroy

World's Largest Manufacturer of
Wireless Telegraphic Apparatus

COMPLETE CENTRAL OFFICE EQUIPMENT

McElroy Manufacturing Corp.

82 Brookline Avenue • Boston, Massachusetts

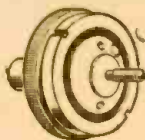

"WONDER" ELECTRIC BUTTON

Most interesting electrical apparatus ever discovered. Make your own Telephone Amplifier rooms. Perform hundreds of fascinating experiments. So tiny it can be concealed in dozens of places. Send \$1 now for button and free 5,000 word instruction booklet with 50 illustrated experiments. SPECIAL OFFER 6 buttons and booklets sent postpaid for \$5. Write now to
BUCK MFG. COMPANY North Aurora, Illinois

FADA Permanent NEEDLES



List
\$1.00

Special Introductory Offer 39¢
(TO DEALERS ONLY—IN LOTS OF 6 OR OVER)

- Plays 4M Records without changing
- Better Tone Reproduction
- Help Reduce Record Hiss
- Longer Record Life

FADA OF NEW YORK
928 BROADWAY NEW YORK 10, N. Y.

Large Stock of Replacement Parts and Cabinets



**WE'VE GOT THOSE HARD
TO GET RADIO PARTS!**

SEND FOR OUR
LATEST FLYER
TODAY!

You'll be surprised at the many hard-to-get parts we've been able to get for you fellows. Mike's, pickups, multimeters, meters and many other items. They're yours as long as they last. Send for latest flyer. It's full of merchandise you've been trying to get! Stocks won't last long, so write today.



QUICK SERVICE!

Our central location in the heart of the nation makes it possible to give you quicker service.

In these days of scarcity we have done everything possible to bring you the best in radio parts and equipment. In spite of existing shortages we have made available thousands of items as shown in our printed circulars.

We are determined to give you the same quick service on "hard-to-get" parts as thousands have enjoyed in the past. Because parts move so rapidly these days we intend to continue our policy of publishing an up-to-date list of merchandise every two or three months.

As additional equipment is released, we will be the first to have it. If you are not on our list to receive our flyers—mail the coupon today.

Sincerely,
Leo J. Morgan
W9GFQ

WE SPECIALIZE IN HALLICRAFTERS

Service men all over the world are learning that the name "Hallcrafters" stands for quality in radio equipment. For many years we have been one of the country's largest distributors of Hallcrafters—"the radio man's radio." We have Hallcrafters available for immediate delivery on priority. For full particulars, write us today.

WHOLESALE RADIO LABORATORIES

744 WEST BROADWAY
COUNCIL BLUFFS, IA.

OUR LATEST GET-ACQUAINTED OFFERS



TUBE AND CIRCUIT REFERENCE BOOK

Here's a handy reference book that meets the demand for simple, easy to understand data on substitution of radio tubes. Contains valuable technical information on tubes and circuits. It's a guide you'll refer to time and again. Send for your copy today! Only 10c post-paid.

TUBE-BASE CALCULATOR ONLY 25c



Here's just the calculator you've been looking for! Tells you quickly, tube characteristics that enable you to substitute available tubes for those hard to get. Only 25c. We pay shipping expense.

FREE Giant Radio Reference Map



Time zones, amateur zones, short wave stations. Other valuable information. Printed in colors; size 3 1/2 x 4 1/2 ft. Yours free! Send 15c to help with packing and mailing.

Mail Coupon Today

Wholesale Radio Laboratories RC-2
744 West Broadway
Council Bluffs, Iowa

Send your Reference Book, "Tubes and Circuits." Here's my 10c.

You bet I want a Tube-Base calculator. 25c is enclosed.

Ship me your free radio map. 15c is enclosed for packing and mailing.

Send your free flyer of hard-to-get radio parts.

Name

Address

Town State

for Parts

Ten thousand different radio and electronic parts immediately available on priorities.

for Service

Trained expeditors select and ship, same day your order is received.

for Experience

Known since 1922 for the high character of our policies and practices—as jobbers, wholesalers and manufacturers.

CONTACT

Radio Wire Television Inc.

100 SIXTH AVE., DEPT. A-2, NEW YORK 13, N. Y.
BOSTON, MASS. • NEWARK, N. J.

WORLD'S LARGEST
RADIO SUPPLY HOUSE

Originators and
Peacetime Marketers
of the celebrated

Lafayette Radio

Write today for our bargain flyers
and special bulletins.

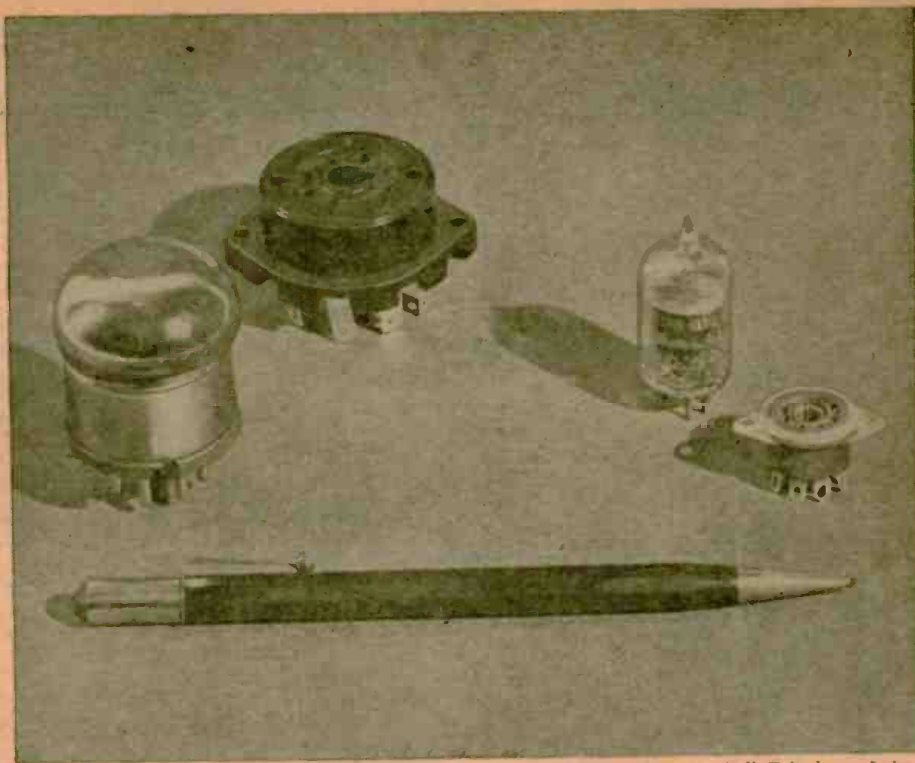

Photos Courtesy Bell Telephone Labs

Small sockets as well as small tubes save space. The 6AK5 compared with the older 717A.

MIDGET TUBE FOR H-F

It has been said that the most important inventions of the present age is the multi-electrode electronic tube. Its use has made possible tremendous strides in the control, measurement, generation, transmission and detection of electricity.

Research and experiment have resulted in rapid development of new vacuum tubes. Among the most recent are the 6AJ5 and 6AK5 pentodes. They were produced by the Bell Telephone Laboratories, which combined pre-war work on a highly efficient midget vacuum tube for broad-band carrier systems with H.F. requirements of the armed forces. At frequencies of about 50 megacycles, these tubes provide more than twice the signal-to-noise ratio obtainable from any other tube!

The 6AK5 is shown alongside its World War I counterpart in Fig. 1. Not only is the former distinctly smaller, but its Gm is 12 times greater! The internal construction (magnified 10 times) is shown in Fig. 2. The spacing between control grid and cathode is only .0035 inch. While manufacturing difficulty due to close electrode spacing is great, the result is a reduction of input capacitance, lead inductance, power requirements and noise level.

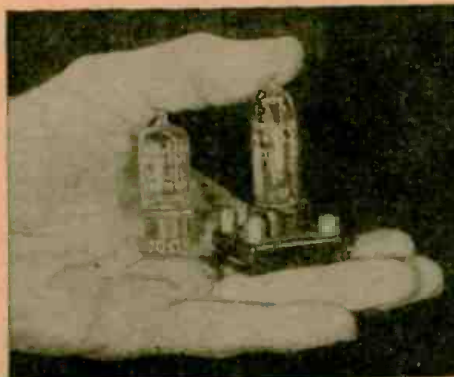

Fig. 1—The 6AK5 and the 215A peanut tube.

The table lists 6AK5 constants. The 6AJ5 is similar except that maximum plate and screen voltage is but 28, and it is therefore convenient for aircraft use. Although its total power consumption is only half that of the 6AK5, its Gm is still high (2750).

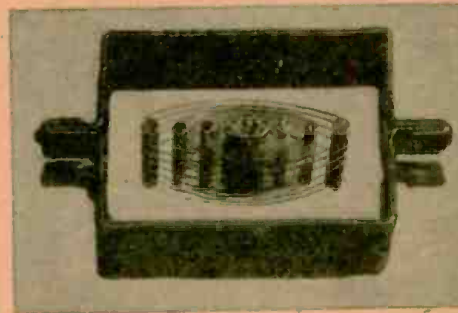

Fig. 2—Showing the close element spacing.

6AK5 CHARACTERISTICS

Max. diameter	3/4"
Overall height	1 3/4"
Filament volts	6.3
Filament current	175 Ma.
Normal plate volts	120
Normal screen volts	120
Normal grid volts	-2
Plate current	7.5
Screen current	2.5
Transconductance	5000
Input capacitance	4 μf.
Output capacitance	2 μf.
Plate-grid capacitance	.01 μf.

Comparison of the listed constants with those of ordinary tubes will indicate the excellent results to be expected from these new tubes in suitable equipment. They are being manufactured at present for use in air-borne and other mobile equipment for high priority purposes.—I.Q.

RADIO-AUDIENCER METER (Continued from page 290)

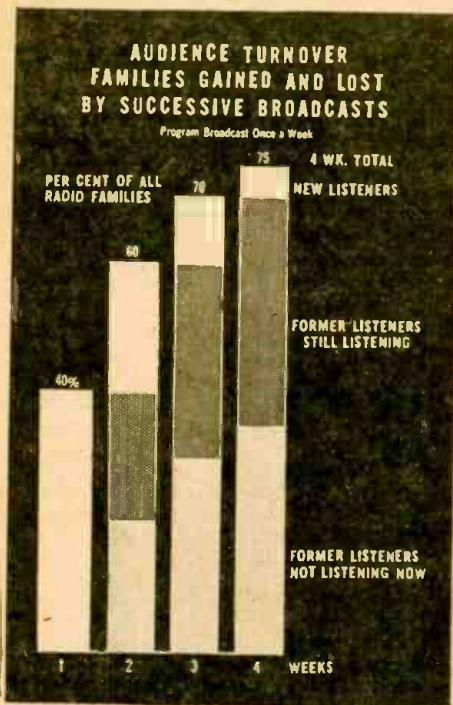

Fig. 3—A chart to show audience turnover.

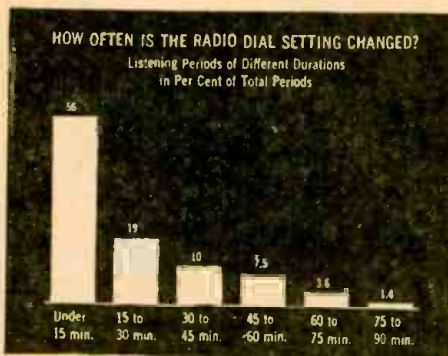

Fig. 4—This chart shows how many tune out.

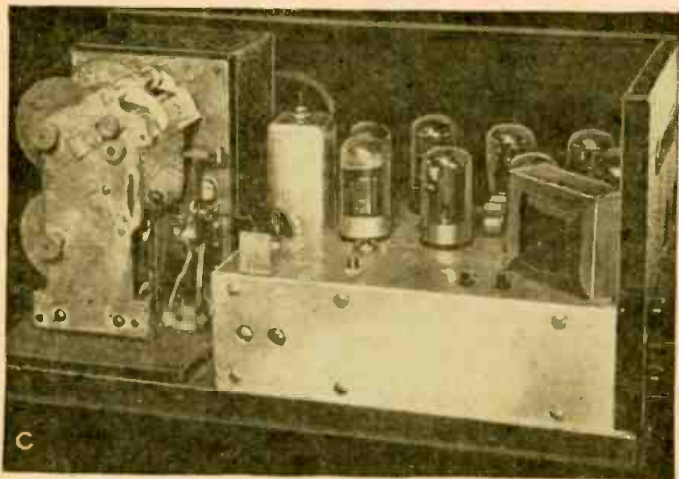

Photo C—The Hunter Audimeter, a remote recorder used in connection with table models where it is inconvenient to install the Audimeter near a radio. It may be put in a closet at some distance from the set.

Many interesting facts have been discovered. Two sixty-minute programs are compared in Fig. 2.

Audience turnover is gauged in Fig. 3, showing how a given program gained and lost listeners over a four-week period. Fig. 4 shows how often average radio dials are changed. We see that 56% of all listening periods are under 15 minutes duration. This is an important chart, as it is the most direct indication of the listener's interest. If the dial is changed every fifteen minutes, it is certain that there is a continuous and attentive audience on hand.

Advocates of the Audimeter believe that this method overcomes disadvantages of the telephone surveys used in other methods of audience measurement. The Audimeter does not merely indicate that someone is listening to a program at a given instant—it shows whether or not that particular program has been able to hold the attention of the given listener throughout. Even more important, is that it is applicable to non-telephone homes, whose radio and purchasing habits are extremely likely to differ from those of the mass of telephone homes.

Against these considerations is urged the fact that the system does not directly show whether any listening is done—it merely records tuning. In many cases a set may be tuned to one station all morning or afternoon. Obviously the standard of attention in such cases must be low, and in many instances the radio may run for considerable periods with no one within earshot at all. Another objection is that should a listener tune in a station for a short period of time—turning it out as soon as he grasps the program import—the Audimeter would register a preference for that particular program. The actual fact is that the listener has registered dislike for the offering. There can be little doubt, however, that the film offers remarkable opportunities for intensive study, as all the afore-mentioned tendencies can be deduced from the tape.

We may expect constant improvement of radio programs, so long as radio advertisers and station executives are aware of the public's desires.



CONCORD RADIO CORPORATION'S

New
"SPECIAL SUPPLEMENT"
HARD-TO-FIND
RADIO AND ELECTRONIC
COMPONENTS

16 pages crowded with listings and descriptions of such wartime essentials as...

- METERS
- VOLUME CONTROLS
- RESISTORS
- TEST ACCESSORIES
- SWITCHES
- TRANSFORMERS
- SPEAKERS
- RHEOSTATS
- RELAYS... and hundreds of others!

Each page overflows with critical parts and equipment . . . urgently needed by industry, laboratories, government agencies, training schools, radio servicemen, military services, etc. Everything is the product of a leading American manufacturer. All are first quality. And all are marked at prices typical of startling Concord values! Hurry! Our edition of these supplements is moving fast. And, since all items are subject to prior sale, we suggest that you wait no longer. Send for your FREE copy today!

Rush this coupon . . . and we will send you the new 16-page Supplement by the fastest possible means.

CONCORD RADIO CORPORATION
901 W. Jackson Blvd., Chicago 7, Ill. Dept. RC-25

Please rush me the new 16-page "Special Supplement" by Concord Radio Corp

NAME _____

ADDRESS _____

CITY _____

STATE _____

CONCORD RADIO CORPORATION

Lafayette Radio Corporation

901 W. Jackson Blvd.
CHICAGO 7, ILL.

265 Peachtree Street
ATLANTA 3, GA.

Intra-television—a term coined by W. R. G. Baker to describe television inside an establishment—is likely to find many uses. Speaking at the TBA conference recently, Dr. Baker pointed out that television show-windows, giving passers-by a view of various departments of a store, will become a necessity. Schools offer another large

field. A few of the uses would be classroom instruction by top-notch teachers, home classes for confined pupils, and adult instruction courses. Use in factories for supervision and for inspection in hazardous places has already been thoroughly discussed, and will be a very important industrial use of television.

OHMITE RESISTORS

Your Guide to
DEPENDABLE
RESISTANCE
CONTROL

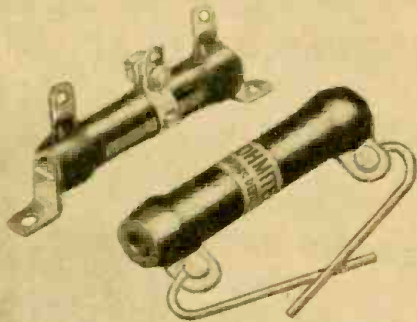

The service-record of Ohmite Brown Devil and Dividohm Resistors before and during the war... is your best guide to resistance-control tomorrow. Widely used in military and industrial equipment... everywhere! Write for Stock Unit Catalog No. 18.

Authorized Distributors Everywhere



OHM'S LAW CALCULATOR

Figures ohms, watts, volts, amperes... easily. Solves any Ohm's Law problem with one setting of the slide. Send only 10c in coin.

OHMITE MANUFACTURING CO.
4894 FLOURNOY ST. • CHICAGO 44, U. S. A.

Be Right with OHMITE
RHEOSTATS • RESISTORS • TAP SWITCHES

An Electronic Mineral Locator

MANY methods, such as seismographic means and resistance measurements, are in use for determining the nature of the earth below its surface. A new principle, simple and effective, is now available in the field of prospecting, for locating surfaces of discontinuity and strata interfaces such as "marker beds" in oil fields. The inventor, Gary Muffy of Penn Township, Pa., has discovered that at such interfaces, distortion of an applied EMF takes place. Two low frequencies are transmitted through the earth and because of resulting distortion at surfaces of discontinuity, rectification and modulation occurs. Additional frequencies (sum and difference) are therefore present and may be detected and measured.

Previous difficulty due to natural ground currents is eliminated, since the latter are usually direct current or slowly fluctuating and cannot interfere with an A.C. detector. Frequencies used may be 100 and 80 cycles per second and voltages in the neighborhood of 1000. Modulation frequencies are therefore 20 and 180 cycles.

Fig. 1 shows the basic arrangements, wherein the electrodes in the earth form a square about 1000 yards on each side. The resultant current paths, both on the surface and below, form melon-shaped figures between electrodes. In a vertical plane half way between them the current path will be horizontal and cannot intercept any hori-

zontal interface which may be present. The straight line joining a set of electrodes is therefore always in a neutral zone. If it exists at all, the modulation effect will be present in the intermediate zones, denoted by dotted lines.

To operate, a fixed electrode is set into the ground some distance from the square while a probe electrode is moved from one position to another. Voltages picked up are filtered (to remove the original 100 and 80 cycles), amplified and indicated on a meter. Equipotential lines and points of maximum potential may then be plotted in the area.

Fig. 2 shows what may be expected when different horizontal interfaces are encountered, for example that between a limestone stratum and one of sandstone. Plotting of voltages will result in a figure such as shown. Note that the voltages at opposite sides of the square diagonals are out of phase.

If the potential curve takes the form of curve A, it will be found that the interface is shallow, if the curve is like B, the interface is deeper and if like C, the discontinuity is very deep. For determining depth the important measurement is the position of the potential maximum rather than its value, which varies with the type of interface. The potential curve corresponds to points on a line through the center of the square and parallel to its sides. Fig. 3 shows a sloping interface and resulting curve.—I.Q.

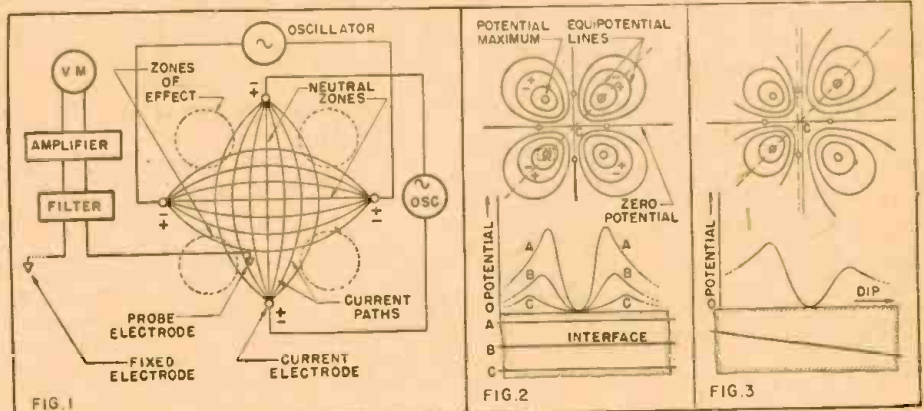

BROADCAST EQUIPMENT (Continued from page 283)

As we have seen, the creation of a broadcast signal which will convey speech and music to the listener's receiver involves the production of a continuous R.F. carrier upon which there is superimposed the program, the wave-shape of whose signal is as nearly identical as possible to that of the original sound produced in the studio. The standard broadcast radiotelephone transmitter is that apparatus wherein a fundamental R.F. wave is generated, amplified, amplitude-modulated, further amplified (sometimes depending upon modulation level), and finally delivered into the radiating system.

The first consideration in the transmitter equipment is the oscillator, which originally generates the R.F. carrier. The F.C.C. requires that "... the frequency of all stations shall be maintained within 20 cycles of the assigned frequency." This means that a maximum frequency drift of ± 10 c.p.s. is permitted. Oscillators controlled by crys-

tals have the greatest frequency stability and are always used in broadcast transmitters.

In its simplest form the crystal oscillator appears as at Fig. 2. It utilizes the crystal's piezoelectric effect, which was previously mentioned in the discussion of the crystal pickup, wherein it was stated that an E.M.F. is generated between the faces of a crystal when a mechanical strain distorts its shape. The converse is also true—an electrostatic charge impressed across the faces will cause the crystal to change its shape. It is this latter property which causes the crystal to behave exactly like an ordinary tuned circuit, the equivalent of which is shown in Fig. 3. L represents the crystal mass which is effective in the vibration, C represents the mechanical compliance or rigidity, R represents the internal resistance due to friction, and C1 is the capacitance due to the holder electrodes and the crystal dielectric.

Several crystalline substances exhibit this piezoelectric effect; among them are quartz, Rochelle salts, tourmaline, and cane sugar. Rochelle salts are the most active in this property, but quartz is used almost exclusively for controlling the frequency of oscillators because of the important advantages it offers. It is inexpensive, has a low temperature coefficient, and is practically impervious to light, shock, moisture, and aging. Furthermore, due to its extreme hardness and low frictional coefficient, it has very low internal resistance, with the result that the circuit has a very high Q. Thus the resonance curve of a quartz plate is extremely sharp. It is this characteristic of the crystal that makes it particularly desirable for use in controlling oscillator frequency. In practice, the selectivity of a crystal circuit may be around 100 times that which can be obtained with an equivalent LC circuit.

It must be borne in mind that although the slab of quartz used as a resonator is usually referred to as a "crystal," it is not actually an entire crystal, but only a section of one cut to certain dimensions and specifications. Plates are cut from a natural quartz crystal at various angles to its electrical, mechanical, and optical axes, resulting in varying electrical and mechanical characteristics.

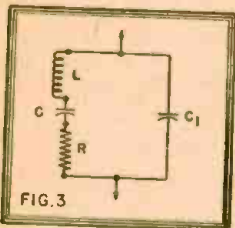

Fig. 3—The quartz crystal acts like a very high-Q coil-condenser combination.

Frequency stability of a quartz plate resonator depends upon the tuning of the output circuit, oscillator tube operating voltages, power taken from the tube, type of crystal cut, and ambient temperature. The first three factors depend upon the design and operating characteristics of the circuit, and are usually maintained constant. The latter two, however, are inter-related variables of considerable importance. The type of cut of the quartz plate determines its "temperature coefficient of frequency," which is usually expressed in terms of frequency change in cycles per second, per megacycle, per degree Centigrade. This coefficient may be either positive, i.e., frequency varies directly as the temperature, or negative, with frequency decreasing with increasing temperature. This calculation is not quite as complicated as it may first appear, and this can be best demonstrated by an actual example.

Suppose we have a 1,400-Kc. X-cut crystal, calibrated at 50° C., having a negative temperature coefficient of 20 cycles per megacycle per degree Centigrade, and we desire to find at what frequency it will oscillate at 60° C. First we see that the temperature has increased 10° C. Then at one megacycle the frequency would change by (10 x 20), or 200 c.p.s. Since the calibrated frequency is 1.4 megacycles, the frequency departure from this frequency would be (1.4 x 200), or 280 c.p.s. The temperature has increased and the coefficient is negative; hence the drift is minus and is subtracted. The new frequency is (1,400 - 0.28), or 1,399.72 Kc. Any such calculation is made in this way, with due regard for the polarity of the coefficient.

Practical means of eliminating crystal drift will commence our discussion next month.

(To be continued)

G-E TUBE CHECKER

Quick, easy, accurate tube checking which saves you time and trouble and keeps your customers happy—that's the job the TC-3P is built to do. Line Voltage and tube quality, or shorts, may all be checked on one selector switch. Individually operated switches permit placing the proper voltage on the proper pin of the tube. The G-E Tube Checker is available in either the Portable (TC-3P) or Counter Model (TC-3). Write: Electronics Department, General Electric, Schenectady, N. Y.

GENERAL ELECTRIC

177-D1

Electronic Measuring Instruments

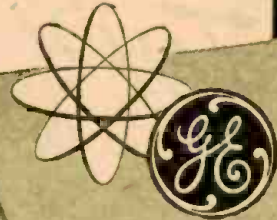
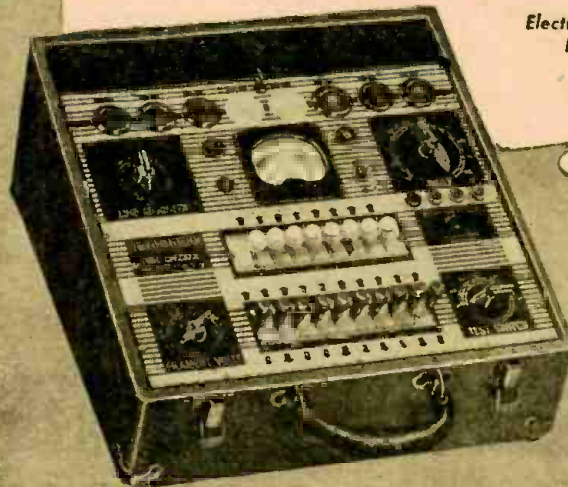

TC-3P

NEW FM RECEIVING SYSTEM

(Continued from page 279)

features include an input impedance characteristic designed to improve lock-in operation of the oscillator. The discriminator also, by its narrow response range, shares some of the work of reducing response to amplitude variations in the signal.

The new system is not only likely to offer an improvement in FM reception—it will also render a service in pointing out that improvements may often best be made by attacking the problem from a new and unexpected direction.

Abstracted from "A Frequency-Dividing Locked-In Oscillator Frequency-Modulation Receiver" by G. L. Beers in the December, 1944, *Proceedings of the I.R.E.* Drawings are also reproduced by courtesy of the Institute of Radio Engineers.

Dr. Frederick E. Terman, author of the standard works *Radio Engineering* and *Radio Engineers Handbook*, has been appointed dean of the School of Engineering of Stanford University at Palo Alto, California.

1	14	15	4
12	7	6	9
8	11	10	5
13	2	3	16

ANSWERS TO ELECTRONIC PUZZLE

(Page 303)

The numbers add up to 34 in every direction, if answers are correct.

MEN! I'll Finance Your Training for a REAL Post War Future in ELECTRICITY



H. C. Lewis

Get Ready for Steady Pay —12 WEEKS TRAINING

After the war—what? Can you step into good-pay peace-time work or is your experience too "one sided"? 12 weeks in the big COYNE shops in Chicago prepares you for the greatest opportunity field, Electricity.

"LEARN-BY-DOING"

Learn power-house work, motors, house-wiring, air conditioning, illumination, maintenance, etc. Also Industrial Electronics included now at no extra cost. Work on actual equipment — "Learn-by-Doing."

EARN WHILE LEARNING

I'll help you get part time work if you need it, to help out with living expenses while training, and let you pay most of the tuition after graduation. Free life-time job service. Trained men in big demand.

FREE BOOK gives full details. Send for it now.

MAIL COUPON TODAY FOR FREE BOOK

H. C. LEWIS, Pres., COYNE ELECTRICAL SCHOOL
500 S. Paulina St., Dept. 25-78, Chicago 12, Ill.
Send me BIG FREE BOOK with all details on Coyne Training, "Pay After Graduation" plan, Lifetime Employment Service, and extra course in Industrial Electronics.

Name _____
Address _____ Zone _____
City _____ State _____

Industrial Electronics has achieved sufficient importance to warrant opening a school for training in that subject alone.

The school is an activity of Industrial Electronics, Inc. and the Visual Training Corp., both of Detroit. Designed primarily for returning veterans, instruction is open to any qualified person.

DEALERS



STOP!
don't
throw it away!

Let **RTS** reprocess
your dead

RADIO TUBES

NEW Scientific Process

**REACTIVATES THORIUM
CONNECTS OPEN FILAMENTS**

**CLEARs SHORTS and
MICROPHONICS**

(NOT the old "flash" trick)

MINIMUM ORDER 6 TUBES

SEND NO CASH **50¢** EA.

C. O. D. ONLY 1 volt & 3-Q5 \$1.00

30-Day Guarantee
Every tube fully tested in checkers & sets before playing

APPROVED BY OPA

Send itemized list with order

Make sure glass, base & prongs are intact... flashed, exploded or open cathodes **REJECTED** and **NOT RETURNED**

RTS RADIO TUBE SERVICE CO. INC.

6805 20th Avenue, Brooklyn 4, N.Y.

LUMINESCENT RADIOS (Continued from page 281)

watt tubes, but their suitability to radio design is questionable. Also available, although probably not of specific interest to the radio man, is a 4-watt bulb type, "360 BL" fluorescent lamp which operates only on a 24-volt direct current. Being discharge lamps, the fluorescent tubes require circuits of proper design and shielding to prevent interference. Provision also must be made for suitable starting of such lights.

The argon glow lamp may be of particular value for use with the lower price sets. Available in various sizes from a 1/4-watt to a 2 1/2-watt bulb (maximum output size at the present time), these lamps offer a wide range of inexpensive exciting light sources rich in long wave length ultraviolet, but low in output.

When phosphorescent pigments are used only for their afterglow properties, light sources containing appreciable amounts of visible energy may be used for excitation to phosphorescence. Sunlight is therefore a most efficient and satisfactory exciting light source, with the afterglow effective in the dark. The lighting systems—fluorescent and incandescent—in regular use today also are satisfactory, as are all "black" lights.

Fluorescent pigments are specially manufactured inorganic compounds produced under conditions insuring the greatest possible purity. They are generally zinc sulfides and combinations of zinc and cadmium sulfides, and are relatively fine in particle size. These pigments are suitable for incorporation in plastics and paper, and for the manufacture of fluorescent paints and inks.

Fluorescent pigments are available in a range of colors from blue to red. The daylight colors vary from white to yellow, but this color may be modified slightly with the addition of small amounts of suitable transparent dyes with only little apparent loss in fluorescence.

PHOSPHORESCENT PIGMENTS

Phosphorescent pigments may be divided into two groups: (1) Those having a short (up to two hours) afterglow and (2) those having a long (6 to 10 hours and more) afterglow.

The short-afterglow phosphorescent pigments are also zinc sulfides and combinations of zinc and cadmium sulfides. In the manufacture of these pigments, high temperatures are used in their calcination, resulting in coarser particle size with certain

fractures in the crystalline structure of molecules which trap some portion of electrons for later emission of light (afterglow). These pigments are quite stable, and suitable for most applications. They are available in light green, pale yellow, and yellow-white daylight colors (modifiable with suitable dyes) and brilliant green and orange-yellow afterglow.

The long-afterglow phosphorescent pigments are calcium and strontium sulfides, prepared by calcination at higher temperatures. They are quite coarse in particle size, and have faults in molecular structure that trap electrons for longer periods of time. They make satisfactory phosphorescent plastics, paints, coated paper, silk screen plates, and textiles. These long-afterglow pigments are sensitive to moisture, requiring care in incorporation if exposure to moisture or water in use is expected. The daylight colors are off-whites and a pale green, which may be modified with appropriate dyes. The phosphorescent colors are violets, blue and greenish-blue.

PRACTICAL APPLICATIONS

Luminescent pigments have been used in the war effort in connection with a variety of applications involving night operations with the dark-adapted eye. Many of these applications undoubtedly will be carried over to peacetime. Fluorescent dials on combat planes point to fluorescent dials on the post-war radio, particularly the television set. A logical application in connection with this development would be fluorescent programs for distribution to the radio owner. Carrying this thought one step further, fluorescent pigments may bring color to a television reception room and, at the same time, permit safe movement in the room without the use of regular lighting. This application could employ fluorescent draperies, upholstery, lamps and shades, pictures and murals, and other articles.

Phosphorescent pigments, too, may be used in connection with the decorative effect, and also to make the trade-mark plate luminescent. A name plate that continues to glow after the radio is turned off would leave a lasting impression of the maker's name on the viewers' minds. Dial knobs and parts of the cabinet, particularly if made of plastic, also could be luminescent—phosphorescent in the lower priced units and fluorescent in sets which are equipped with "black" lights.



FRANK BEAVEN

Suggested by Thomas Jewett, Clyde, Ohio.

"He's sore because he can't get his favorite radio stations on his handie-talkie."

A PRIMER OF AVIATION RADIO

(Continued from page 272)

ments over the Adcock range. Repeated field tests have proved that instabilities of the low frequency range are not nearly so evident on the VHF. While these so-called line-of-sight ranges will not service as large areas as a low frequency range, they are cheaper to install. It is possible to use more of them because of their absence from reflected sky waves.

In flying a range aurally, because of the inability of the human ear to detect changes in signal level of less than about one-half decibel, there can be many different interpretations of the twilight zone. This zone is the area where either the A or N fades into the on-course signal. Two aircraft may be flying the same range leg in different directions, observing the opposite twilight zones to prevent collision.

In the VHF range system visual legs, signals which cannot be used aurally, but operate an indicator on the instrument panel, are available. This instrument is a zero-center meter. When an equisignal course is being followed there is zero deflection. Flying to the right or left of the course will cause the vertical needle to deviate to the right or left and thereby indicate in which way to correct the aircraft heading. The visual range leg is accurate within much closer tolerances than the aural leg because of the ability of the indicator to detect small changes in signal intensity. The aural VHF range leg is also sharper than the low frequency range leg.

The *cone of silence* is an area of no signal directly over the radio range and is used for orientation and navigation. The cone is more clearly defined on the VHF, but in either case it is a negative indication rather than a positive one. The *Z marker* was developed for the specific purpose of giving an indication when passing over the range station. The marker consists of a low power transmitter and a directive antenna array, operating on a frequency of 75 Mc. It projects a vertical beam through which aircraft will pass when flying over the range station. A special receiver without tuning controls provides both aural and visual indication. The visual indicator is a small colored instrument light.

The *fan marker* also operates on 75 Mc. and is used along the airways as an aid to navigation and traffic control (see Fig. 3). The name is derived from the fan-like pattern of radiation. This pattern is keyed in such a manner as to offer positive identification and prevent any possibility of confusing it with other fan or Z markers. Passing through the elliptical shaped pattern gives an instantaneous fix without interfering with the radio range. By the use of different modulating tones and suitable filters on the receivers, the outer and inner markers on the instrument landing system, the fan markers and Z markers—all operating on the same frequency—can be made to actuate different colored lights on the instrument panel.

The most widely used instrument landing system operates entirely on the VHF. The system consists of four principal elements, the *localizer* which is a visual type two course radio range; the *glide path*, and *inner* and *outer* marker. The localizer transmitter produces a visual radio range course along the center of the runway (and a reciprocal course on the other side of the transmitter). In some instances the VHF radio range and localizer may be combined. This is generally not done because traffic flying the range would be delayed by aircraft land-

(Continued on following page)

HALLICRAFTERS ★ HALLICRAFTERS



COMPLETE STOCKS

I have in stock some Hallicrafters receivers available for immediate delivery on priority and the following parts without priority: meter rectifiers \$1.95, transmitting tubes, transformers, resistors, condensers, panels, headsets, etc. Your orders and inquiries invited.

RECEIVER HEADQUARTERS

for the Nation

BEFORE the war Bob Henry served the amateurs as the world's largest distributor of communications receivers.

Now Henry Radio is Hallicrafters receiver headquarters for the Nation at war. Hallicrafters Receivers can be supplied on AA-1 priority. I can usually supply SX28As at \$223.00, SX-25s at \$94.50, and PM-23 speakers at \$15.00 at once. It takes longer to supply other models.

Soon, it is hoped, non-priority orders can be filled and Bob Henry can become again Hallicrafters headquarters for the nation at peace.

I have stores at Butler, Missouri, and at 2335 Westwood Blvd., Los Angeles 25, Calif.

Your orders and inquiries are invited.

Bob Henry, W9ARA
HENRY RADIO SHOPS

Butler, Mo. and Los Angeles, 25, Calif.

"WORLD'S LARGEST DISTRIBUTOR OF COMMUNICATIONS RECEIVERS"



ATTENTION— DEALERS and SERVICEMEN! RADIO CITY MODELS 446 AND 423 MULTITESTERS

NOW AVAILABLE WITHIN
30-60 DAYS ON AA-5 PRIORITY

Place your orders Now!

Here are two very popular instruments, combining ruggedness, comprehensive ranges and low cost. A great opportunity to get top-quality instruments at these low prices. Better place your orders now.



Illustrated Above: Model 423

A.C.-D.C. Multitester—RANGES:

D.C. voltmeter: 0-5-50-250-500-2,500 volts. A.C. voltmeter: 0-10-100-500-1,000 volts. Output voltmeter: 0-10-100-500-1,000 volts. D.C. milliammeter: 0-1-10-100-1,000 milliamperes. D.C. ammeter: 0-10 amperes. Ohmmeter: 0-500-100,000 ohm; 1 megohm. Decibel Meter: minus 8 to plus 55 decibels.

MODEL 446A is an open-face instrument supplied in a hardwood, walnut-finish case, 5 7/8" x 3". Weight 21 oz. Complete with batteries, ready to operate... **\$13.45**

MODEL 446AP is the portable type. Complete with batteries, ready to operate... **\$15.45**

Volt-Ohm-Milliammeter—RANGES:

D.C. voltmeter: 0-2.5-10-50-250-1,000 volts. A.C. voltmeter: 0-10-50-250-1,000 volts. D.C. milliammeter: 0-10-50-250-1,000 milliamperes. Ohmmeter: 0-500-100,000 ohms; 1-10 megohms. Decibel meter: -10 to 15-4 to 29-18 to 43-30 to 55 db. Db range is calibrated for a 500-ohm impedance line. For lines of other impedances, correction charts are supplied.

MODEL 423 is supplied in a hardwood, walnut-finish case, 7 1/4" x 5 3/4" x 3 3/4". Weight 2 lbs. Complete with self-contained batteries, ready to operate... **\$23.50**

MODEL 423P is similar to 423, but is supplied in a portable, solid walnut, hand-rubbed case. Complete with batteries and set of test leads, ready to operate... **\$25.95**

Contact our nearest branch, listed below, for rapid delivery.

**RADIO ELECTRIC
SERVICE CO.**

Main Store: N. W. Cor. 7th & Arch Sts., Philadelphia, Pa.

— BRANCHES —
PHILADELPHIA:
3145 N. Broad St., 5135 Market St.
ALLENTOWN, PA.:
1042 Hamilton St.
CAMDEN, N. J.:
513 Cooper St.
WILMINGTON, DEL.:
219 W. 8th St.

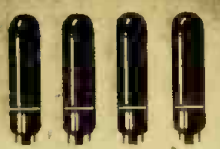

4 STANDARD TYPES
of Amperite Regulators replace over 400 types of AC-DC Ballast Tubes now in use.

Amperites are real REGULATORS . . . have patented Automatic Starting Resistor which prevents initial surge and saves pilot lights . . . Ask Your Jobber.

AMPERITE

THE *Simplest* WAY TO REPLACE **BALLASTS**

WRITE FOR REPLACEMENT CHART
AMPERITE CO. 561 BROADWAY, NEW YORK, N. Y.

IMMEDIATE DELIVERY

RADIO PARTS

- Kit No. 1—100 1/4-Watt carbon resistors—color coded \$1.95
- Kit No. 2—100 carbon resistors—25 1-Watt, 75 1/2-Watt . . . \$2.94
- Kit No. 3—100 1/3-Watt insulated resistors—color coded . . . \$2.94
- Kit No. 4—100 assorted by-pass and buffer condensers. List price over \$20.00 \$5.83
- Kit No. 5—25 popular assorted by-pass condensers \$1.59
- Hook-up and Push-back Wire—89c per 100 ft. 10 assorted 100-ft. rolls only \$7.80
- Kit No. 6—20 assorted trimmer and padder condensers96
- Kit No. 7—50 assorted terminal lugs—2 to 6 lugs96
- Kit No. 8—50 assorted rubber grommets69

Write for our latest bulletin listing hundreds of necessary items for the radio and soundman.

LIFETIME SOUND EQUIPMENT CO.
P.O. BOX 834 TOLEDO 1 OHIO, U.S.A.

(Continued from previous page)

ing under instrument conditions. The vertical needle used as the localizer indicator is also used for the visual VHF range legs, since both transmitters are operating under the same conditions. If the pointer is in the vertical position the aircraft is on the bisector of the runway regardless of the plane's heading. Indications to the right or left of the runway are readily observed to an accuracy of 1°.

The glide path needle is pivoted in a horizontal position. When approaching the field for an instrument landing the needle is held in a horizontal position. If the needle is above the horizon the plane is below the glide path. If the needle is below the horizon the plane is above the glide path.

The outer and inner markers used in this system are of the fan type. As the aircraft passes over the outer marker it will operate a purple-colored indicator light. This is a check point to indicate the proper altitude for a definite position. The inner marker will flash an amber-colored indicator light as the plane passes through it. The inner marker is located just before the runway and serves as a final check point. Because of the proven dependability of the markers and the difficulty in controlling the angle of the glide path, this latter feature may not become standard equipment for some time.

There are numerous other instrument landing systems now under development, especially those designed around the radar and electronic discoveries arising from wartime research.

Emphasis has been laid on the radio range and other airway navigation aids. However, planes make wide use of omnidirectional radio signals such as broadcast stations, aircraft and marine radio beacons, and even keyed signals from fixed radiotelegraph stations. The CAA has medium power homing transmitters located at various fields for use with loop direction finders. Primary use of these aids is on long over-water flights where radio ranges give inadequate coverage. By the use of manual or automatic radio direction finder loops navigation problems are quickly, accurately, and simply executed.

Ground radio facilities which can fix the position of aircraft are now widely used. The principal type is the cathode-ray Adcock system which can take bearings of greater accuracy on the medium and high frequencies than the aircraft loop. This system avoids the necessity of manipulating the loop, and gives an instantaneous bearing by producing a spot or line on the cathode screen on the relative azimuth of the aircraft. In general practice the plane holds down the transmitter key and the ground station obtains a bearing. Several of these stations working together can obtain a fix in the same manner as the aircraft uses its loop to take cross bearings on more than one signal source. These fixes may be taken under favorable conditions over one thousand miles from the plane.

Ground to aircraft teletype is just one of the many new devices awaiting the final victory before experimentation can be successfully concluded. Radio controlled automatic pilots are the logical development to follow the *Flurgate* and *Gyrosyn* compass. The *terrain clearance indicator* is expected to become standard equipment as will many other new units of aircraft radio still in the experimental stage. A rather thorough acquaintance is the minimum requirement for the radioman if he does not want to become hopelessly outdated in his knowledge of aircraft radio. This primer has touched the high spots in the hope of showing the importance of such an acquaintance with aviation radio.

FOR SALE HARD-TO-GET ITEMS

All items are brand new, except where indicated. ALL are in PERFECT WORKING ORDER. In many cases, the parts alone total more than the price we are asking. Satisfaction guaranteed or your money back. ORDER FROM THIS PAGE. Use our convenient coupon. Include sufficient extra remittance for parcel post charges, otherwise order is sent express collect. Any excess will be refunded. All C.O.D. shipments require 20% deposit. No C.O.D. shipments on orders for less than \$5.00. If full remittance accompanies order deduct 2% discount. Send money order, certified check, or new U. S. stamps. No C. O. D.'s to foreign countries.

THE MAGIC ELECTRIC WELDER



Here is one of the most compact, practical welders we have ever seen. Anyone can use it for shop, farm and home repairs. WELDS, BRAZES, SOLDERS, CUTS ALL METALS. ANYONE CAN OPERATE IT. Repairs steel, cast iron, aluminum, brass, copper, bronze, etc. Complete with power unit, flame and metallic arc attachments.

(Really two welders in one). Carbons, fluxes, rods, mask included. Just plug it in any electric outlet. 110 volts AC or DC. For hobbyist or professional.

GET IN ON THE GREAT WELDING BOOM. This fine set quickly teaches you welding. Low cost to operate—about 10¢ an hour. COMPLETE SAFETY is assured. No fumes with this outfit. SET COMES COMPLETE—nothing else to buy.

Used by the U. S. Navy, American Tel. & Teleg. Co., Eastman Kodak Co., Bell Laboratories, etc. BRAND NEW OUTFIT. Guaranteed for one year. Simple instructions with each set.

ITEM NO. 158
YOUR PRICE \$19.95

WESTERN ELECTRIC BREAST MIKE

This is a fine light-weight aircraft carbon microphone. It weighs only 1 lb.

Mike comes with breastplate mounting and has 2-way swiveling adjustment so that it can be adjusted to any desired position. There are 2 woven straps; one goes around neck, the other around chest. Straps can be snapped on and off quickly by an ingenious arrangement.

This excellent mike can be adapted for home broadcasting or public communication systems. By dismantling breastplate, it can be used as desk mike.

Comes complete with 6-foot cord and hard rubber plug. Finished in stainless steel. Non-rustable.

THIS IS A BRAND NEW MIKE. IT HAS NEVER BEEN SOLD AT SUCH A LOW PRICE BEFORE. ORIGINAL LIST PRICE \$15.00. Shipping weight, 2 lbs.

ITEM NO. 152
YOUR PRICE \$2.55

POWERFUL ALL-PURPOSE INDUCTION MOTOR

IDEAL FOR EXPERIMENTERS—101 USES

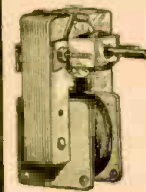

Sturdily constructed to precision standards, this self-starting shaded pole A.C. induction motor is powerful enough for a number of uses. Some of these are: Automatic Timing Devices, Current Interrupters, Electric Fans, Electric Chimes, Window Drights, Photocell Control Devices, Electric Vibrators, Small Grinders, Buffers and Polishers, Miniature Pumps, Mechanical Models, Sirens, and other applications.

Consumes about 15 watts of power and has a speed of 3,000 r.p.m. When geared down, this sturdy unit will constantly operate at an 18-inch turntable loaded with 200 lbs. dead weight—THAT'S POWER!

Dimensions 3" high by 2" wide by 1 3/4" deep; has a convenient mounting studs; shaft is 1/8" long by 3/16" diameter and runs in self-aligning oil retaining bearings. Designed for 110-20 volts, 50-60 cycles, A.C. only. Shp. Wt. 2 lbs.

ITEM NO. 147
YOUR PRICE \$2.25

LIMITED QUANTITIES! PROMPT SHIPMENTS!

It's Easy to order—Clip Coupon—Order from This Page—No Catalog Sent.

MAIL TODAY—NOW!

HUDSON SPECIALTIES CO.

40 West Broadway, Dept. RC-2-45, New York 7, N. Y.

I have circled below the number of the items I'm ordering. My full remittance of \$ (include shipping charges) is enclosed. (NO C.O.D. ORDERS UNLESS ACCOMPANIED WITH A DEPOSIT.)

OR my deposit of \$ is enclosed (20% required) and order C.O.D. for balance. NO C.O.D. ORDER FOR LESS THAN \$5.00. (New U. S. stamps, check or money order accepted.)

Circle Item No. wanted 147 152 158

Name

Address Please Print Clearly

City State

Send remittance by check, stamps or money order; register letter if you send cash or stamps.

RADIO PILOT LANDS PLANES

(Continued from page 273)

miles. A cross-pointer device on the airplane instrument panel indicates whether the aircraft is flying above or below the glide path; when the two needles come together at a right angle, the flying machine is therefore indicated to be on the true flight path.

The 2½-degree glide-corridor angle is equivalent to a 400-feet-per-minute rate descent, at a ground speed of 100 miles per hour. The glide-path may also be employed as a rough index to the distance of the airplane from the runway, inasmuch as each 200 feet of altitude represents about one mile of distance from the airport. If, for example, the airplane's altimeter indicates 1,000 feet when the plane is descending on the glide-track, the pilot knows that the plane is about five miles from the end of the runway.

THE GROUND EQUIPMENT

As previously indicated, the ground radio equipment consists of the localizer transmitter, installed in a truck and placed 1,000 feet from the upwind end of the runway. Marker transmitters are hauled in jeeps to varying locations.

Radio equipment in the airplanes receive the signals from the ground radio transmitters. Both localizer and glide-track radio receivers intercept impulses on a combination antenna or on two individual antennae, depending upon the type of the airplane. A small control box, readily accessible to the pilot, enables him to select any one of six radio receiving frequencies for the localizer, and any of the three wave lengths for the glide-path beam.

To bring an airplane to rest (still the most difficult feat of flying) by this blind landing system, the pilot approaches the airport on the conventional guiding radio beam, by his automatic radio compass or by other radio aids to navigation. When at a distance of 20 miles of the airfield, the pilot switches on the right channel or frequency for making a landing at a certain airfield. Then he "brackets" the localizer and navigates until the glide-track is intersected. At a height of 2,500 feet, the pilot intersects the glide-corridor when 13 miles from the airfield. At this juncture, he starts his glide along the glide-path, lowering the airplane wheels and flaps, thus curtailing the power and increasing the revolutions per minute as the aircraft approaches the airport.

Upon breaking through a screen of low-hanging clouds, the pilot is able to continue his descent onto the runway. Flight tests have indicated that an expert pilot can negotiate a complete blind landing on the runway, although the system has been dedicated to the function of lifting the weather hazard of overcast by flying blindly—and safely—through it.

FORECAST OF FUTURE FLYING

The electronic airplane in the post-war world will be flown by remote control, governing the rate of climb and glide, measuring the thickness of obscuring clouds, indicate the position of an on-coming plane ten miles away, and automatically land the craft smoothly and safely with an electronic or radio indicator.

Future trends indicate the use of a complete automatic electronic or radio pilot. The localizer and glide-path signals, discussed in this article, would actuate a specially-designed radio receiver which, in turn, would transmit adjustments to "Elmer," the gyro-pilot, which would fly the plane down to the runway. It would be actually one automatic device operating another electrical and automatic gadget, the electronic pilot. Of course, the flesh-and-blood pilot would make power adjustments and lower the gears and flaps when landing blindly and automatically.

"Shooting of Landings by Radio," a descriptive phrase of *Air Force* in defining the radio blind landing system discussed in this article, have been introduced in England recently, and in trial experiments as many as six airplanes in succession were brought into one airport without entangling difficulties.

Staffs for post-war television and FM stations will be available from the ranks of army- and navy-trained technicians, declared Commander William C. Eddy, U. S. Navy (retired) at the recent Television Broadcasters conference.

SPEED UP REPAIRS WITH THESE G-C AIDS!



FREE
STEEL
CABINET

G-C DIAL BELT KITS

Exact replacement woven fabric belts. Easy to install—no stretching—no adjustments—a perfect fit every time. Kits come with 25, 50, 100, 200 or 300 belts.



G-C AUTOMATIC WIRE STRIPPER

Strips insulation from all types of wire. Does the job instantly, easily, perfectly. An ideal tool for radio men, electricians and sound men.



G-C CONTACT SERVICE KIT

Contains special contact cleaner and corrosion resistant lubricant. You can clean noisy controls nine times out of ten without dismantling chassis or control unit. Pays for itself over and over.



Order From Your Radio Parts Jobber
ALWAYS ASK FOR G-C PRODUCTS

GENERAL CEMENT MFG. CO.

ROCKFORD, ILLINOIS

ELECTRICITY

for Radio and
Electronic Applications

ONAN ELECTRIC GENERATING PLANTS supply reliable, economical electric service for electronics applications as well as for scores of general uses.

Driven by Onan-built, 4-cycle gasoline engines, these power units are of single-unit, compact design and sturdy construction. Suitable for mobile, stationary or emergency service.

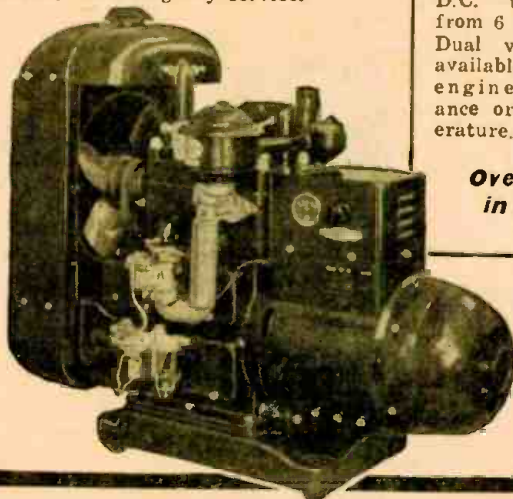

Models range from 350 to 35,000 watts. A.C. types from 115 to 660 volts; 50, 60, 180 cycles, single or three-phase; 400, 500, and 800 cycle, single phase; also special frequencies.

D.C. types range from 6 to 4000 volts. Dual voltage types available. Write for engineering assistance or detailed literature.

Over 250,000
in service

Model Shown is from W2C series, 2 and 3-KW, 60-cycle, 115 volt; powered by water-cooled, 2-cylinder engine.

D. W. ONAN & SONS 2412 Royalston Ave.,
Minneapolis 5, Minn.

Radio Servicemen:

RADIO PARTS—TUBES

BARGAIN PRICES—NO PRIORITIES

King P.M. Speakers, 4 or 5 inch	\$1.19
King 450 Ohm Speakers, 4 or 5 inch	1.49
Filter Cond., 20-20 Mfd., 150 V.	.39
By-Pass Cond., .05 or .1 Mfd., 600 V.	.07
Dial Cable, Light or Medium, 25 ft.	.25

Write Today for Bargain Bulletin

RADIO DISTRIBUTING COMPANY,
P.O. Box 497—PASADENA 18, California

Guaranteed Rebuilt Radio

VIBRATORS—\$1.00 ea.

Send old vibrator. For very prompt delivery, enclose remittance and return postage. We rebuild any make or kind of vibrator or relay. Vibrator packs rebuilt also. Send your old vibrator to
BEST VIBRATOR CO., Box 5802-Z, Cleveland 1, O.

FOR SALE

HARD-TO-GET ITEMS

All items are brand new, except where indicated. ALL are in PERFECT WORKING ORDER. In many cases, the parts alone total more than the price we are asking. Satisfaction guaranteed or your money back. ORDER FROM THIS PAGE. Use our convenient coupon. Include sufficient extra remittance for parcel post charges, otherwise order is sent express collect. Any excess will be refunded. All C.O.D. shipments require 20% deposit. No C.O.D. shipments on orders for less than \$5.00. If full remittance accompanies order deduct 2% discount. Send money order, certified check, or new U. S. stamps. No C. O. D.'s to foreign countries.

ULTRA MAGNET

LIFTS MORE THAN 20 TIMES ITS OWN WEIGHT

LITTLE GIANT MAGNET

Lifts 5 lbs. easily. Weighs 4 oz. Made of ALNICO new high-magnetic steel. Complete with keeper. World's most powerful magnet ever made. The experimenter and hobbyist will find hundreds of excellent uses for this high quality permanent magnet. Measures 1 3/4" x 1 1/2" Shp. Wt. 8 1/2 lbs.

ITEM NO. 159
YOUR PRICE \$1.50



GENUINE MICROPHONE TRANSMITTERS



These are regular "telephone transmitters" of the type used on wall telephones. Taken from a large telephone supply company's overstock, these fine mikes offer a grand opportunity to obtain a splendid unit for little more than the price usually asked for a simple "microphone button." The amateur experimenter and telephone mechanic will find a variety of uses for these excellent microphones. They work perfectly on 2 dry cells.

Can be used on P.A. systems for voice transmissions, in call systems and intercommunications sets. With telephone receivers (radio headphones will do) they may be made into short-line telephone circuits, such as house-to-house or farm-to-farm phone circuits. You can use them to talk through your own radio, or as concealed diaphone pick-up units for listening to conversations in a distant room or building. The telephone mechanic will find them useful replacements on battery-operated rural telephone lines.

THESE ARE GENUINE TRANSMITTERS, MADE BY KELLOGG, WESTERN ELECTRIC AND STROMBERG-CARLSON, excellent in appearance and operation. A remarkable value, and one seldom offered in these times. Shp. Wt. 1 lb.

ITEM NO. 160
YOUR PRICE \$1.50

AMAZING BLACK LIGHT!!!

Powerful 250-Watt Ultra-Violet Source



The best and most practical source of ultra-violet light for general experimental and entertainment use. Makes all fluorescent substances brilliantly luminescent. No transformers of any kind needed. Fits any standard lamp socket. Made with special filter glass permitting only ultra-violet rays to come through. Brings out beautiful opalescent hues in various types of materials. Swell for amateur parties, pinys, etc. to obtain unique lighting effects. Bulb

only. Shp. Wt. 2 lbs.
ITEM NO. 161
YOUR PRICE \$2.45

WATTHOUR METER

Completely overhauled and ready for immediate service. Designed for regular 110 volt, 60 cycle 2-wire A.C. circuit. Servicemen use it in their shops to check current consumption of sets, soldering irons, etc. Keeps costs down. If dismantled, the parts alone would bring the price. The elaborate gear train could be used as a counter on machines of various kinds. Simple to install. 2 wires from the line and 2 wires to the load. Sturdily constructed in heavy metal case. 8 1/2" high, 6 1/4" wide, 2" deep. Westinghouse, G. E., Ft. Wayne, Sangamo or other available make. Shp. Wt. 14 lbs.



ITEM NO. 33
YOUR PRICE \$5.95

LIMITED QUANTITIES! PROMPT SHIPMENTS!

It's Easy to Order—Clip Coupon—Order from This Page—No Catalog Sent.
MAIL TODAY—NOW!

(See Corresponding Ad Page 314)

HUDSON SPECIALTIES CO.
40 West Broadway, Dept. RC-2-45, New York 7, N. Y.

I have circled below the numbers of the items I'm ordering. My full remittance of \$..... (include shipping charges) is enclosed (NO C.O.D. ORDERS UNLESS ACCOMPANIED WITH A DEPOSIT.) OR my deposit of \$..... is enclosed (20% required) ship order C.O.D. for balance. NO C.O.D. ORDER FOR LESS THAN \$5.00. (New U. S. stamps, check or money order accepted.) Circle Item No. wanted: 33 87 159 160

Name

Address Please Print Clearly

City State

Send remittance by check, stamps or money order; register letter if you send cash or stamps.

ULTRA RADIO (Continued from page 278)

any of the paper. After the letters and markers are traced, they can be put out with a pair of scissors. The inactive side of the papers are cemented on to the knobs and panel with dope. After this is thoroughly dry the active side is coated once or twice with dope, being careful not to smear any of the liquified lacquer finish on the panel onto the chemical. The dope will keep the chemical from wearing off. It will be found that when the dials are exposed to the light for a short time, that they will give off a purple glow in the dark.

OPERATING POINTERS

Proper use of the receiver is as important as proper construction. The operating power is obtained from any 110 to 120 volt line, supplying either alternating current or direct current. If direct current is used, the power plug may have to be reversed to get the right polarity. Portable or emergency operation is possible with 90 to 112 1/2 volts from heavy duty "B" batteries. Battery operation was found to be very satisfactory, except for the drain placed on the batteries.

The antenna is made of a stiff length of copper wire soldered to a phone tip, so that it can be plugged into a socket post. The length should not exceed a yard. The antenna can also consist of a few feet of insulated wire, if desired.

The continuous oscillation of the superregenerative type of receiver may cause interference with near-by short wave receivers. If any experimenting is to be done with out-door aerials it is advisable to connect a radio frequency amplifier between the detector and aerial. The use of an out-door aerial is not necessary, and the author recommends the use of a 15 inch antenna with the sensitive circuit shown here.

If the superregeneration control is advanced to a point further than necessary, the receiver may howl, therefore the control is set to the point where pure superregeneration is present. The control may have to be varied as the wave length is changed. The point at which the oscillation is correct for reception may vary in width; in some instances it may cover two-thirds of the adjustment area.

While the plug-in coil is being changed, the "B" power should be turned off by means of the stand-by switch. The tapped coil's

selector switch should be turned to one of the taps, which are marked for the particular plug-in coil being used. As this is an A.C.-D.C. receiver, a ground should never be used. Care should also be taken to make certain that the operator will not be grounded by any objects such as radiators, pipes, damp floor, cement, etc.

The characteristic superregenerative hiss

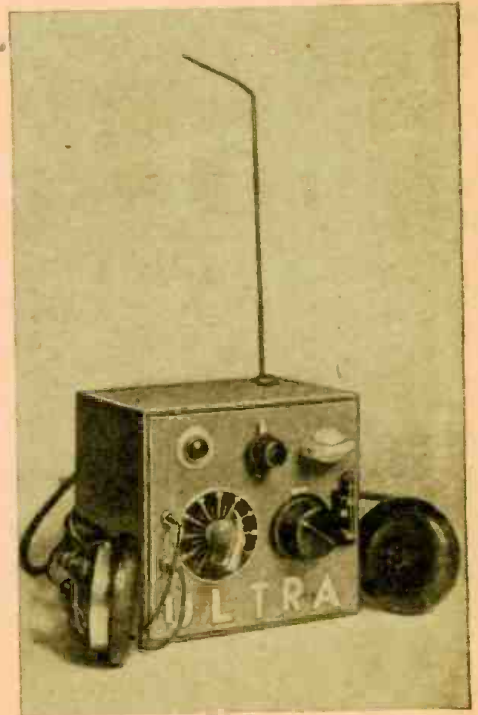

This view of the Ultra with its headphones gives an excellent idea of its compactness.

will be present on all frequencies if the receiver is oscillating properly. When a station is tuned in the hissing sound fades into the background, thus a lack of hiss within the oscillating band will usually indicate a station. Code wireless stations may be rather hard to read, because of the silent space present when the station is sending out a dot or dash, and the hiss sound present when the station is not sending.

CL1 TAPS	COIL	CL2	CL3	Approximate Wavelength
O	A	2 1/2 turns spaced No. 20 wire	3 3/4 turns close No. 28 wire	10-18 meters
O	B	4 1/4 turns spaced No. 28 wire	4 1/2 turns close No. 28 wire	16-21 meters
O	C	4 1/4 turns close No. 28 wire	4 3/4 turns close No. 28 wire	19-24 meters
O-1	D	4 1/4 turns close No. 28 wire	7 1/2 turns close No. 36 wire	23-35 meters
O-4	E	5 1/4 turns close No. 28 wire	11 1/2 turns close No. 36 wire	35-75 meters
O-6	F	7 1/4 turns close No. 28 wire	21 turns close No. 36 wire	75-120 meters

Fig. 2—Coil data table for Ultra or similar S-W receiver. Coil forms are tube bases.

Ultra will be found to be a real distance getter. It has been tested over a period of two years, and was found to be really satisfactory for regular stable foreign reception. The small size makes it easily portable and equally fine results will be had in almost any locality.

Parts List

CONDENSERS

- C1, C2—20 mfd. 150 V.D.C. dry electrolytic Sprague "Atoms" Tu 220
- C3—140 Mmfd. tuning condenser
- C4—4 plate midget band spread condenser (such as used for neutralizing a neutrodyne receiver)
- C5—.02 mfd. tubular fixed condenser
- C6—.005 mfd. tubular fixed condenser
- C7—.00025 mfd. tubular fixed condenser
- C8—.001 mfd. tubular fixed condenser

RESISTORS

- R1—1000 ohms fixed wire wound resistor
- R2—10 megohm fixed carbon resistor
- R3—150 ohm fixed carbon resistor
- VR4—50,000 ohm potentiometer with switch (Sw. 1)
- R5—2 megohm fixed carbon resistor

MISCELLANEOUS ITEMS

- 1—117P7-GT radio tube
- 1—Octal socket
- 6—4 prong tube bases
- 1—SPST bakelite knife switch (Sw. 2)
- 1—7 connection selector switch (Sw. 3)
- 2—Single phone posts
- 1—Single insulated post for antenna
- 1—Masonite front panel (see text)
- 1—Hadley 4 1/2" x 3 1/2" x 1" chassis
- 1—Home built case
- 1—Roll of hook-up wire
- 1—1 1/4" x 1 3/4" bakelite form for coil CL1
- 4—Pointer knobs
- 1—Power cord and plug
- 9—Screws and nuts

RECORD CHANGERS

(Continued from page 286)

of doing things gets results he will persist in doing them that way. A few tactful remarks can result in the discovery of such a situation and, once the true cause of the trouble is known, a bit of helpful advice to the owner will eliminate a possible call-back.

4. Use of Old Records

An example of unintentionally improper operation is the use of phonograph records of ancient vintage. Many still in use date back to "tin-horn" days. Unfortunately, the man who made them had none of the qualifications of Nostradamus. Not being able to predict the future, he failed to design them to work on an automatic record changer.

This is not difficult to explain if a new record is available for comparison. The *eccentric groove* around the center can be pointed out as the means for actuating the repeat cam. This will not be found on the old record. Also, old records can be seen to vary from the standard thickness of modern records.

(Never suggest the obvious cure of discarding the old records. Remember, they are valuable "heirlooms," to be broken only by grandchildren.)

Symptoms

Failure to repeat and jamming of the record selector mechanism.

5. Bent Records

The worst treatment that can be accorded phonograph records is to forget to remove them from the selector blade supports and leave them there for several days. In this position, the stack of discs is not resting on a flat surface like the turntable, but is supported either from two points at the sides, or at one side and the center. In the first case the discs will sag in the center and in the second they will sag at the unsupported edge. When this sag becomes fixed the recordings may be so badly warped that they

(Continued on following page)

Choose the CANNON BALL HEADSET You Like Best



Scientifically Built Heavy bar magnets greatly increase their efficiency.

Rugged construction. Inside or outside terminals. Sensitive. Clear tone. Dependable quality. Headset Headquarters guarantees satisfaction. Write for folder R-2.

C. F. CANNON COMPANY
SPRINGWATER, N. Y.

LEARN RADIO-ELECTRONICS TELEVISION, SOUND SYSTEMS, ETC.

"Learn by Doing" 12-WEEKS Training IN COYNE SHOPS

Train now for a good job and a peace-time future in Radio-Electronics. Free employment service after graduation. Earn while you learn. If short of money, I'll finance your training.

We have facilities for men with physical disabilities. If you have a physical disability of any kind write me when you send coupon.

Send coupon today for all details. H. C. Lewis, Pres., Radio-Electronics Div., Coyne Electrical School, Dept. 25-4H, 500 S. Paulina St., Chicago 12, Ill. Send Free Book and details of "Pay-After-Graduation" plan.

NAME _____
ADDRESS _____
CITY _____ STATE _____

RADIO-ELECTRONIC REFERENCE-ANNUAL

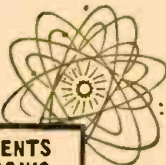

1944

PARTIAL CONTENTS RADIO-ELECTRONIC REFERENCE ANNUAL

ELECTRONIC THEORY AND GENERAL PRACTICE is thoroughly covered in this book in easy-to-grasp language. Among the articles on this subject are: What You Should Know About Electronics—Electronic Tubes for Servicemen—The Electronic Solvovox, Its Theory and Action—and The Photoelectric Phonograph Pickup, the principles underlying its operation.

ELECTRONIC DEVICES YOU CAN BUILD Among the interesting and easily constructed devices selected are the following: Compact Hearing Aid—Oscillex Automatic Key and Code Machine—Electronic Relay, Caspely and Light Operated, High Frequency Radiotherapy, a complete home apparatus—and many other timely types of electronic apparatus.

RADIO CONSTRUCTION Many well-illustrated, do-it-yourself articles, such as: Phono Oscillators, several types, adapted to playing records through your radio with a simple record player—T.R.F. Sets—Superheterodynes—Power Packs for Portable Receivers, making it possible to use your battery portable on the electric light line—A two-tube Super Midget Amplifier, which is a palm-of-the-hand public address system—and many others.

SOUND AND RECORDING Including detailed instructions on constructing: High-Fidelity Amplifier—Exponential Horn with perfect reproduction down to 50 cycles—Electronic Expander—Compressor—Also the Robson Technique—Semi-Pro Recording—Electronic Bass—and Treble-Expanding Circuits—Equalizers, etc.

TEST INSTRUMENTS A complete line including: A Tube checker with universal hookup, can check any tube regardless of the prong to which its elements are brought out—Complete Multimeter, 18 ranges of voltage, current and resistance on 11-point, 2-line switch—A Three Tube Signal Tracer, capable of checking R.F. and audio circuits—A Condenser Analyzer which measures both capacity and checks leakage—and an Electron-Ray Voltmeter which dispenses with hard-to-get millimeters, using a 6E5 tube instead.

SERVICING Articles on servicing supply a multitude of methods and useful ideas, including Dynamic Testing with Signal Generator—Modernizing Test Set—Calibrated UHF Oscillator—and countless other hints for ironing out kinks in your servicing problems.



FREE—if you subscribe now to



Are you asking yourself: "What's next in Radio and Electronics?" What mysterious inventions are brewing in radio research laboratories? What effect will these wartime secret inventions have on peacetime conditions? Will the scientists take me into new, unfamiliar fields, requiring special technical education?

Keep Posted With Radio-Craft

Radio is once again at the crossroads! All must become students again of a science that has experienced a marvelous rebirth through ELECTRONICS. The question about the near and distant future now racing through your mind will be answered step by step in the forthcoming issues of RADIO-CRAFT.

You Need This Free Reference Annual, Too!

You can't plan intelligently ahead—you can't grasp the new—until you have thoroughly mastered the tried and accepted present-day radio developments. And that is where the REFERENCE ANNUAL comes to your aid. This fact-packed book is THE radio man's digest. It's the spark that bridges the gap between the RADIO-ELECTRONIC WORLD OF TODAY and the COMING POST-WAR WORLD.

And think of it—you can get it absolutely free and postpaid by subscribing to RADIO-CRAFT now—but you must act quickly as war-paper shortage compels us to limit the printing. If you are already a subscriber we can extend your subscription.

CUT OUT AND MAIL

RADIO-CRAFT
25 West Broadway
New York 7, N. Y.

Be sure to use coupon or mention Free Reference Annual when ordering. No billing.

TIME LIMIT OFFER

RADIO-CRAFT WITH FREE COPY RADIO-REFERENCE ANNUAL

- 1 Year \$2.50
- 2 Years \$4.50
- 3 Years \$6.00

If you are already a subscriber we can extend your subscription if you will check "Extension" box.

Gentlemen: I want to take advantage of your Special Time Limit Offer for your RADIO-ELECTRONIC REFERENCE ANNUAL—1943-1944, which you will send me ABSOLUTELY FREE and PREPAID in connection with my subscription to RADIO-CRAFT and Popular Electronics for the period checked below. No billing on this Special Offer.

I enclose my remittance of \$ _____
 1 Yr. \$2.50 2 Yrs. \$4.50 3 Yrs. \$6.00
 This is a new order Renewal Extension

Name _____ Please print clearly

Address _____

City _____ Postal Dist. No. (if any) _____ State _____
(Canadian 50c extra. Foreign 75c extra per year. Send by International Money Order.)

TECHNICAL PERSONNEL WANTED

IS *Your* OPPORTUNITY HERE?

Think this over carefully. Where do you go from the spot you're in now? Are your surroundings friendly and full of promise for the future? Consider now the place you might fill in the electronic industry leadership assured to the fine staff of engineers, scientists, technicians at NATIONAL UNION RADIO CORPORATION. We're all young in years and ideas though most of us are old in electronic experience. We enjoy working together. We know we're going places! We're inviting you to join us if you have the qualifications. If you're looking for a success pattern for your future, it may be here with us at National Union. Find out! Come in and talk it over or write us!

NATIONAL UNION WANTS:

- * **QUALITY CONTROL ENGINEER AND SENIOR TUBE ENGINEERS**
—These men **MUST** have executive ability and extensive experience with radio tube manufacture. The pay and opportunities are commensurate with your ability.
- * **COMMERCIAL ENGINEERS**—Men with pleasing personalities, initiative and a knowledge of vacuum tube applications.
- * **QUALITY CONTROL MEN**—Statistical Training is chief requirement though a knowledge of vacuum tubes will help.
- * **JUNIOR ENGINEERS—MEN or WOMEN**—If you have a college degree in Physics, Electrical Engineering, Mathematics or Chemistry and are the type of young person who is able to 'go places,' you'll be starting with your best foot forward if you are accepted at National Union Radio Corporation.
- * **FOREMEN and ASSISTANT FOREMEN**—Men with foremanship experience in exhaust, stem or grid operations in radio tube manufacture.
- * **TECHNICIANS, CIRCUIT MEN**—Maybe you've been repairing radios, maybe you've gained a knowledge of circuits by working on test equipment. It makes no difference either way if you have the 'know how' of circuits write us about the opportunities we have to offer!

WOMEN!

We have a number of fine young women engineers with us now. We need more. If you have a degree in Electrical Engineering, Physics, Chemistry or Mathematics and are seeking career opportunities, investigate.

Phone or Write

DR. L. GRANT HECTOR

—Director of Engineering

NATIONAL UNION RADIO CORPORATION RESEARCH LABORATORIES

Plane St. at Raymond Blvd.
Newark 2, New Jersey
WMC RULES OBSERVED

ELECTRICAL and RADIO ENGINEERS RADIO TECHNICIANS

FOR DESIGN, DEVELOPMENT
AND PRODUCTION WORK
POST WAR OPPORTUNITY

ALLEN D. CARDWELL MFG. CORP.
81 Prospect St. Brooklyn

WANTED

RADIO LICENSED AMATEURS

thoroughly familiar with all types of parts, tubes, meters, test equipment, receivers, transmitters, etc. Permanent position; excellent salary; splendid opportunity for some one residing in metropolitan New York area.

SUN RADIO & ELECTRONICS CO.
212 Fulton Street New York 7, N. Y.

(Continued from previous page)

cannot rest flat on one another and the selector blades will not be able to slide between them to separate one record at a time from the stack.

Symptoms

The "wow" effect of warped records on the music is well known and many complaints that the motor is "dragging" or alternately speeding up and slowing down can be traced to this reason, especially if the unit refuses to misbehave when the repair man is present.

Before actual repair work can be accomplished a device must be provided by which the player can be supported in a right-side-up and level position, since this is the only position in which it can be tested for proper operation. The writer finds that two small boxes taken from the stock shelf are quite practical for this purpose (see Fig. 1). Many service men prefer more elaborate supports installed in a permanent phono repair position. Naturally, some operations will require placing the player carefully upside down position (preferably on a felt pad).

Procedure

The most expedient method usually begins with an inspection of the mechanism for broken and defective parts. These are either replaced or repaired, the accent being on the latter procedure at present, due to wartime shortages.

In this connection an important caution should be observed in regard to replacing broken springs. (See Fig. 2.) If it is necessary to stretch a broken coil spring so that it can be put back in its original location, some arrangement must be used to avoid excessive tension. Remember that springs are used merely to bring the levers back to their original positions and minimum tension should be used to avert wear at points of friction.

After mechanical repairs have been effected, resetting of adjustments can be undertaken and will invariably be necessary due to the considerable effect one adjustment has upon another in this type of mechanism.

The underside of a widely used record changer is shown in Fig. 3 with its various components numbered to correspond with their adjustments as listed in the accompanying table (Fig. 4).



Future television sets will look like this, say Barnes and Reinecke, industrial designers and engineers of Chicago. Built into a small cabinet, it will project an image on a large screen. In this model, provision is made for a wire recorder and radio together with television.

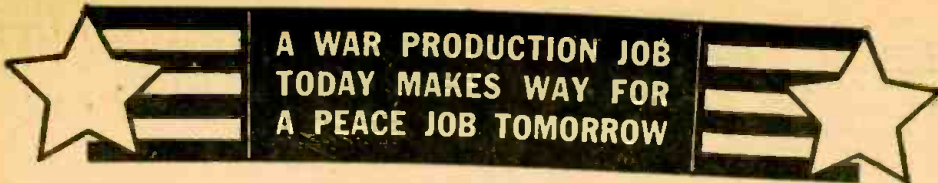

ENGINEERS

Are You Concerned With YOUR POST WAR FUTURE ?

The Federal Telephone & Radio Corporation, the manufacturing unit of the International Telephone & Telegraph Corporation with its multiple business activities extending to all parts of the civilized world, will accept applications from experienced men for immediate employment with almost limitless post war possibilities. These positions should interest those with an eye to the future and whose interest lies in forging ahead with this internationally known organization whose expansion plans for post war are of great magnitude covering all types of radio & telephone communications. Advancement as rapid as ability warrants. Majority of positions are located in the New York area!

We need the following personnel! Men with long experience or recent graduates considered.

- ENGINEERS
 - ELECTRONICS
 - ELECTRICAL
 - RADIO
 - MECHANICAL
 - CHEMICAL
 - TRANSFORMER DESIGN
- SALES AND APPLICATION ENGINEERS
- PHYSICISTS
- DESIGNERS
- DRAFTSMEN
- TOOL DESIGNERS
- TECHNICAL WRITERS

Look Ahead With Federal!

If inconvenient to apply in person, write letter in full, detailing about yourself, education, experience, age, etc., to Personnel Manager.

FEDERAL TELEPHONE & RADIO CORP.
39 Central Avenue
EAST NEWARK NEW JERSEY

Transmitting or Receiving RADIO STATION TECHNICIANS

MEN AND WOMEN

for Point-to-Point International Radio-communications Stations in the United States.

Applicants must possess at least Second Class Commercial Radiotelegraph Operator's License.

Essential workers need release statement.

Apply weekdays except Saturdays between 10 am and 3 pm

or write

PERSONNEL DEPARTMENT

R.C.A. COMMUNICATIONS, Inc.
64 BROAD STREET
NEW YORK 4, N. Y.

HELP WANTED

TRANSFORMER & SMALL ELECTRIC MOTOR MEN

ENGINEERS DESIGNERS DRAFTSMEN TECHNICIANS

For war time and post-war design and development of intricate, specialized, hermetically sealed transformers, and special purpose fractional h.p. motors.

Write, giving details about age, experience, past salaries to

SPERRY

GYROSCOPE COMPANY, INC.
RESEARCH LABORATORIES
STEWART AVE. AND CLINTON RD.
GARDEN CITY, NEW YORK

Wanted ENGINEERS

Radio

*Electrical

Electronic

*Mechanical

Metallurgical

*Factory Planning

Materials Handling

Manufacturing Planning

Work in connection with the manufacture of a wide variety of new and advanced types of communications equipment and special electronic products.

Apply for writel, giving full qualifications, to:

R.L.D., EMPLOYMENT DEPT.

Western Electric Co.

100 CENTRAL AV., KEARNY, N. J.

*Also: C.A.L.

Locust St., Haverhill, Mass.

Applicants must comply with WMC regulations

FIELD SERVICE ENGINEERS

For Domestic and Foreign Service

Must possess good knowledge of Radio

Essential workers need release.

HAZELTINE CORPORATION

58-25 Little Neck Parkway
Little Neck, Long Island

ENGINEERS DESIGNERS

ELECTRICAL, MECHANICAL,
RADIO, ACOUSTICAL

For Research and Development Laboratory of large company fully engaged in war work manufacturing aircraft accessories. Activity includes electronic control equipment, continuous recorders, special radio devices, etc.

Excellent post-war opportunities. Laboratory located in central Manhattan. All replies strictly confidential.

Write or phone our personnel director

LEAR, INCORPORATED

1860 Broadway, New York, N. Y. Tel. Circle 6-5685



HIGH-VOLTAGE requirements

● Aerovox Type 12 is an immersion-proof oil-filled paper capacitor designed to meet high-voltage, high-altitude operating requirements. Particularly suitable for high-voltage circuit applications such as in television, cathode-ray tube power supplies, high-voltage rectifier circuits, aircraft transmitters, or as a high-voltage by-pass capacitor. Note barrier in bakelite top. This further increases insulation and creepage path between terminals.

AEROVOX TYPE 12 HVOL

Supplied with adjustable mounting ring for vertical mounting. For certain less critical applications, ceramic insulators may be removed and unit used without them.

Voltage ratings from 2000 to 7500 volts d.c.w. Capacitances from .01 to 2.0 mfd., depending on voltage.

For high-voltage high-altitude operation, particularly aircraft, units can be had with special porcelain cover and single, taller insulator pillar terminal with corona shield.

● Write for Literature . . .



AEROVOX CORP., NEW BEDFORD, MASS., U. S. A.
 In Canada: AEROVOX CANADA LTD., HAMILTON, ONT.
 Export: 13 E. 40 St. New York 16, N. Y. Cable: 'ARLAB'

through produce vibrations, the ribbons being alternately attracted and repelled.

Assume a constant magnetic field. When the additional field (due to current) adds to the constant field, the ribbons separate (5-a). When one opposes the other, the ribbons approach (5-b). Full modulation is obtained when they touch and open to twice normal separation alternately. This is disadvantageous, since overload causes ribbon clash and possible damage. Also, distortion is introduced due to the slit height not remaining constant. The previously-mentioned caution—transformations must be linear—applies here.

Noise during quiet intervals is due to fine grain, scratches, and dirt on the transparent areas. Fig. 6 represents a typical "noise-free" system using the triangle variable area method, similar principles being applicable to all types.

The luminous triangle is mounted on a galvanometer, free to vibrate vertically. Exposure is obtained only from that area at the slit. The galvanometer has two windings, one for the A.F. input, the other for a biasing D.C. potential which follows the envelope of the first. The latter is obtained from the original A.F. by detection and filtering, similar to the manner in which an AVC voltage is produced from modulated R.F. in a radio receiver.

During silent intervals, there is no biasing voltage and the triangle is at position A. At 50% modulation, the D.C. obtained from the audio voltage biases the galvanometer so that the triangle assumes position B (and vibrates about this mean position). At full modulation the average triangle position is at C, where it may vibrate from one extreme to the other. Thus, only sufficient transparent areas to carry the necessary modulation are placed before the photocell. During periods of no input the track is therefore opaque.

PHOTOGRAPHIC ANGLES

Certain principles of photography must be followed. Much difficulty is eliminated by using two separate films, one for the picture, the other for the sound.

When a film coated with silver bromide crystals is exposed to light and suitably processed, it darkens, the crystals changing to metallic silver. The still transparent (unexposed) areas are maintained by placing the film in a hypo solution which causes loss of sensitivity to light. The film is therefore a negative and may be printed by placing between an unexposed film and a source of light. Obviously the latter film will be a positive.

Interior of projection mechanism. Lower section in rectangular housing is sound reproducer. Note the tubular incandescent lamp at extreme right, which projects image of sound track through lens system in partition to photocell at extreme right.

—Photo Courtesy Electrical Research Products, Inc.

Now the film must darken in proportion to the light striking it. Film laboratory technicians make use of a curve (H & D curve) plotting density vs. logarithm of exposure for the given film. These curves exhibit a middle linear portion and are non-linear at each end. By definition, density equals logarithm of opacity, so the plot is really opacity vs. exposure, and we require a straight-line characteristic. The slope (gamma) of the curve determines film contrast and varies with developing time, exposure, type of film, etc.

TESTING THE NEGATIVE

Variable-density film has an output determined by its contrast (gamma) which must be maintained essentially constant. To determine correct gamma, test strips are recorded, developed to different gammas, printed and projected to find which results in least distortion and sufficient volume.

The variable-area film is not concerned with contrast, there being present only an area of opacity and one of transparency, so that only the density must be controlled, a comparatively simple matter. A density of 1.6 on the negative, about 1.4 on the positive is usually attained, but this is not critical. Direct reading densitometers, (Eastman Kodak type) are available.

The sound output depends upon difference in density between the light and dark sections of the track. The obtainable density is limited by the nature of developing chemicals which cause "fog" should we process the film too long in an effort to obtain a higher density value. A fog density not greater than .04 on the transparent area is permissible. If greater, the high frequency modulations will fill in and become lost.

It is good practice to record test strips containing sibilant or "s" sounds, since they are usually lost first. The strip having least distortion and adequate volume is noted for density, developing time, value of recording light brilliancy, etc., and can be used for a guide.

The volume varies as $20 \log (T_1 - T_2)$ where the subscripts refer to the clear and exposed transparencies respectively.

An interesting fact is that a film negative sounds like a film positive since the same variations of exposure (in transposed order) are present. However, a characteristic distortion will be present on the former, because the actual change from a transparent to an opaque area does not take place sharply. This gradual change takes place

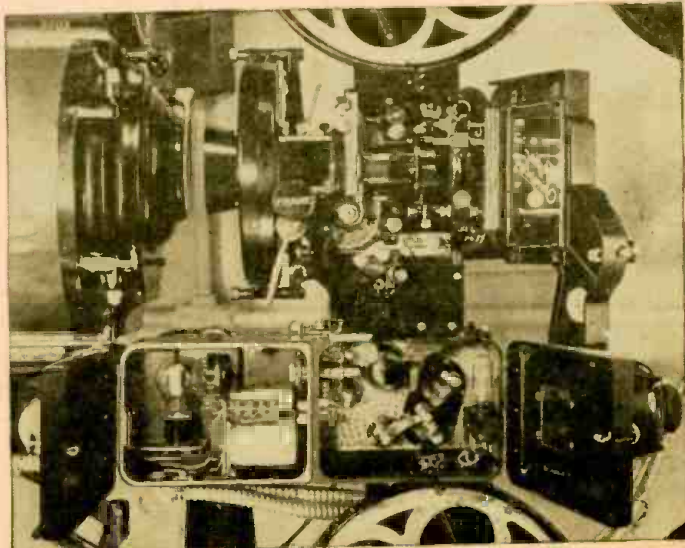

in reverse sense on the positive and is cancelled. Sibillant sounds are especially affected.

RECORDING TECHNIQUE

Hollywood synchronizes camera and recorder with complicated Selsyn motors. The small studios use simple inexpensive motors, synchronic only at high speed, which can operate both off the same line. Action here begins when high speed is obtained through a technique which in the profession is called clacking.

Before a "take", an assistant stands in the camera field with a book or "clapstick" which he slams shut on receiving signals from cameraman and recordist that their motors are up to speed. The picture frame which shows the clapstick just closing corresponds to the track modulations of the sharp report.

As in all recording and broadcasting, apparatus limitations require that the sound be kept high enough to be above noise level and low enough to avoid over-modulation. The sound man therefore manipulates the gain control to obtain a smooth, faithful record, although the average level has been carried up or down.

Special noise-eliminating precautions must be taken. Quiet running machinery is essential and noise-proof booths may be used to house the camera and recorder, the picture being taken through a glass window. Sound-proofing the studio eliminates echoes and reverberation.

Since it is easy to distinguish close-up from distant sound, it is essential to fit the sound to the scene. Obviously a close-up picture accompanied by a far-away sound is ridiculous and disagreeable. Each type of sound has a different ratio of original to reflected energy and the nearer sound has a greater proportion of lower to higher frequencies. A change of scene almost always calls for a change in microphone position.

THAT 11-TUBE SUPERHET

It has been pointed out that the plate circuits of the two sections of the 6K8 in Emmett Brightwell's 11-tube superheterodyne, printed on page 156 of the December, 1944, issue, were interchanged in the drawing. The oscillator and converter plates are actually connected in the orthodox fashion. A decimal point also dropped out of the "0.1-mfd" indicating the condenser between A.V.C. line and ground. This makes it 1 mfd, much too large for an A.V.C. circuit. Another decimal point dropped out in the designation of one of the cathode by-pass condensers, but in this case use of the larger size would make no difference.

Our thanks are due to Mr. J. M. Sherman of Troy, Ohio, who pointed out these errors to us.

THE ELECTRONIC BAT

AUTOMATIC electronic safety devices which will bring a car to a stop when an object looms up before it were predicted last month by Kenneth W. Jarvis, Chicago consulting engineer.

Speaking to the RMA and IRE convention in that city, he showed how a sound-receiving and projecting device could control brakes and gasoline feed, determine distance to the nearest object ahead of the car, slow it down and bring it to a complete stop if necessary to prevent a collision.

The humble bat, equipped for supersonics, has used this collision-prevention system with excellent results for many milleniums.

OPPORTUNITY AD-LETS

Advertisements in this section cost 20 cents a word for each insertion. Name, address and initials must be included at the above rate. Cash should accompany all classified advertisements unless placed by an accredited advertising agency. No advertisement for less than ten words accepted. Ten percent discount on six issues, twenty percent for twelve issues. Objectionable or misleading advertisements not accepted. Advertisements for March, 1945, issue must reach us not later than February 28, 1945.

Radio-Craft • 25 W. B'way • New York 7, N. Y.

CORRESPONDENCE COURSES AND SELF-INSTRUCTION books, slightly used. Sold, Rented, Exchanged. All subjects. Satisfaction guaranteed. Cash paid for used courses. Complete information and 92-page illustrated bargain catalog free. Write—NELSON COMPANY, Dept. 2-39, Chicago 4.

PREPARE NOW FOR TREMENDOUS OPPORTUNITIES in new fields of radio after the war. Training for Federal licenses. Write for particulars, American Radio Institute, 44 East 23rd Street, New York 10, N. Y.

USED CORRESPONDENCE COURSES AND TECHNICAL Books Bought, Sold, Rented. Catalog Free. Educational Exchange, Henaer, Alabama.

SCIENCE ENTHUSIASTS IN ALL FIELDS NOW HAVE a printed monthly written BY them FOR them, 15c brings latest issue. Amateur Scientists' Magazine, 45D North Evergreen, Memphis, Tenn.

RADIO TESTING EQUIPMENT, PARTS, METERS. Will pay any reasonable price if in good condition. Joan Lubinski, 3349 Fulton, Cleveland 9, Ohio.

BUSINESS CARDS PRINTED REASONABLE. Samples, Spada, 10 Lexington, Wethersfield 9, Conn.

SHORT WAVE DX. SEND 10¢ FOR SAMPLE Bulletin to Universal Radio DX Club, 7507 Holly St., Oakland 3, Calif.

RADIO TUBES, PARTS, CONDENSERS, FREE Bargain lists. Potter, 1314 McGee, Kansas City, Mo.

SELENIUM RECTIFIERS, HALF WAVE 4 1/2 AM- Peres, 10 volts \$4.60; full wave 1/3 ampere, 10 volts, \$1.85; 30 volts, 1 ampere, \$3.49. A.B. Eliminator schematic 2c, free with order. Milton Bursa, 105 Avondale, Jackson, Mich.

MAGAZINES (BACK DATED)—FOREIGN, DOMESTIC, arts, books, booklets, subscriptions, pin-ups, etc. Catalog 10c (refund). Clcerone's, 863 First Ave., New York 17, N. Y.

SAL-AMMONIAC TINNING BLOUCHS 50 AND 75 cents. Dealers wanted. Opportune Products, Box 8, Normandy 21, Mo.

BUILD A RADIO, COMPLETE KIT WITH TUBES, \$10.95. Details, Radio, 9418b Avenue "A", Brooklyn, N. Y.

UNIVERSAL MIDGET TOOLS: DANDY SIXTEEN Piece Set: Midget Pliers, Diagonal Cutters, Four Midget end Wrenches, Needle-nose Pliers, Screwdriver, Six Punches and Chisel, Round File Midget Crescent Wrench, \$14.85. Immediate Delivery. Remit Aoday, Catalogue Free With Order. DEALERS TOOL SUPPLY, 1527 Grand Ave. RC, Kansas City, Missouri.

RADIO-CRAFT'S LIBRARY

presents

4 BEST SELLERS

No. 25

HOME-MADE
RADIO TEST
INSTRUMENTS

No. 26

MODERN
BATTERY
RADIO SETS

No. 27

MODERN
RADIO
SERVICING
TECHNIQUE

No. 28

ALL ABOUT
FREQUENCY
MODULATION

HERE are four of the handiest, most informative books that this popular technical library ever turned out. They hardly need an introduction. Their usefulness is already an established fact, proven on the best "proving ground" in the world: "The field of practical application."

Yes, indeed, thousands upon thousands of technicians, servicemen, experimenters, trainees use these books daily. They are just the right size to slip in the pocket so you can read them when traveling.

The knowledge gained from these self-help books can be used in countless ways; for example, in building a home-set, when servicing an outside job; or when preparing for an examination. Many men in the armed service who are aiming toward a higher rating are making excellent use of these books. The price, only 50¢ each, and less when you buy more than one at a time, is trifling when you consider that the first application of the knowledge gained will likely pay the cost of all four books.

No. 25—Home-Made Radio Test Instruments
Outline of Contents: A Low-Cost Signal Chaser—Signal Tracer Test Unit—Simplified Practical Signal Tracer—A Home-Made Infinite Resistance Tube Checker—Build This Direct-Reading V.T. Voltmeter—How to Make a Modern V.T. Voltmeter—Measuring High Values of A.C. Voltage and Current With a Low-Range Meter—How to Make a Meter-Range Extender—How to Build a Practical Tube Tester and Set-Analyzer Adapter—The Beginners' Simple Volt-Milliammeter—How to Make and Use a Frequency Wobbler—Double Tracing Your Oscilloscope—Home-Made Frequency Modulator.

No. 26—Modern Battery Radio Sets
Outline of Contents: Beginners' 1-Tube High-Gain All-Wave Receiver—Beginners-Build This 1-Tube Loop Receiver—A "2-in-1" Battery Portable—An Easily-Built "Flowing Superregenerative" 2-in-1 "Card File" Battery Set—A 2-Tube Superhet. With Pentagrid Regenerative 2nd-Detector—The 4-Tube Superhet. Vacation Portable—"The Lunchbox 5" Battery Portable—"The Seafarer" Loop-Type Boat Radio Set—4-Tube Permeability Portable—An All-Purpose Portable—A Typical Commercial 3-Way Portable (Pilot Models X-1452 and X-1453)—Switch for Varying "C" Bias on Battery Radio Sets—Making a Simple Portable Aerial—Making a Pilot-Light Fuse—Old Auto Sets for New Cars—Using a Loop Portable in Cars—Quasi-Electric Soldering Iron—Lamp Bulbs as Resistors.

No. 27—Modern Radio Servicing Technique
Outline of Contents: Elementary Servicing Technique—Correct Procedure for the Servicing Beginner—Elementary Procedure for Servicing Radio Sets—A.F.C. Alignment Made Easy—Dynamic Servicing—Dynamic Testing—Simplified Servicing—Modern Receiver Test Requirements—Servicing Universal A.C.-D.C. Receivers—Servicing "Orphan" and Private-Brand Sets—Emergency Servicing Without Test Meters—Servicing Coils—Servicing R.F. Coils—Servicing Oscillator Coils—General Information—RMA Transformer Color Code—What Causes Echo, Fading?—Radio Service Puzzlers.

No. 28—All About Frequency Modulation
Outline of Contents: The ABC of F.M.—Frequency vs. Amplitude Modulation—Basic Facts About F.M.—Broadcasting Construction—Build This Practical F.M. Adapter—Audio Amplification—F.M. Audio Amplifier, Part 1—F.M. Audio Amplifier, Part 2—F.M. Audio Amplifier, Part 3—F.M. Service—Part 1. Antenna Installation and Service—Part 2. Receiver Alignment and Diagnosis—Part 3. Test Equipment for F.M. Servicing, Engineering—Part 1. The How and Why of F.M.—Part 2. The How and Why of F.M. Theory and Design Considerations of R.F. and I.F. Coils in F.M. Receivers.

MAIL THIS COUPON TODAY →

All four books are listed uniformly at 50¢ each. No discount on less than three books.

If you wish to take advantage of our special offer, ordering three books or more, we make an unusual low price to you as follows:

3 books—\$1.25 4 books—\$1.50

(The new increased C.O.D. and postage charges are about 50¢. You save this amount by enclosing your remittance with order.)

Do not fail to send coupon today!

RADCRAFT PUBLICATIONS, INC.
25 West Broadway, New York 7, N. Y.

RADCRAFT PUBLICATIONS, INC. 2-45
25 West Broadway,
New York 7, N. Y.
Gentlemen:

Rush to me by return mail, as per your special offer, the following books: (Check books selected.)

No. 25—HOME-MADE RADIO TEST INSTRUMENTS.
 No. 26—MODERN BATTERY RADIO SETS.
 No. 27—MODERN RADIO SERVICING TECHNIQUE.
 No. 28—ALL ABOUT FREQUENCY MODULATION.

WE CANNOT SEND C.O.D.

NAME
ADDRESS PLEASE PRINT CLEARLY
CITY STATE

Remit by Cash, U.S. new postage stamps, money order, check.
Foreign countries add 20% to all prices quoted.

NATION-WIDE
MAIL ORDER
DISTRIBUTORS
SINCE 1928



RADIO AND ELECTRONIC DEVICES

For...

TRADE... INDUSTRY...
COMMUNICATION...
PUBLIC UTILITY...
VOCATIONAL AND
EXPERIMENTAL
APPLICATIONS

BURSTEIN-APPLEBEE CO.

1012-14 MCGEE ST.
KANSAS CITY 6, MISSOURI

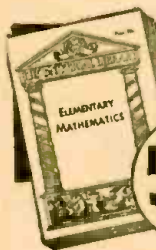

The Book that takes
Drudgery out of
Mathematics

Only
50c
postpaid

Entire Chapter on
Special Mathematics
for the Radio
Technician.

ELEMENTARY MATHEMATICS

● EASY — SIMPLIFIED — PRACTICAL ●

Here is the book that gives you a good background in mathematics; that takes all the irritation and drudgery out of it. You don't need to be scared of mathematics, because here's the subject explained without frills, without useless computations.

CONTENTS OF BOOK

CHAPTER I. Arithmetic—Addition—Subtraction—Multiplication—Division.
CHAPTER II. Factoring and Cancellation—Fractions—Decimals—Percentage—Ratio and Proportion.
CHAPTER III. The Metric System.
CHAPTER IV. How to Measure Surfaces and Capacity (Geometry).
CHAPTER V. Powers and Involution—Roots and Evolution.
CHAPTER VI. Mathematics for the Manual and Technical Craftsman—Thermometer conversions—Graphs or Curve Plotting—Logarithms—Use of the Slide Rule.
CHAPTER VII. Special Mathematics for the Radio Technician.
CHAPTER VIII. Commercial Calculations—Interest—Discounts—Short Cut Arithmetic.
CHAPTER IX. Weights and Measures—Useful Tables.

ONLY
50c
POSTPAID

Send today for your copy of this indispensable book. It can be carried readily in your pocket. (Size 6 x 9 in.)

Send Stamps, Cash or Money Order to

TECHNIFAX

1917 S. STATE ST., RC-2-45, Chicago, Ill.

TECHNIFAX 1917 S. State St., Chicago, Ill.

Enclosed herewith 50 cents, for which mail to address below your ELEMENTARY MATHEMATICS.

NAME

ADDRESS

CITY STATE RC-2-45

The Mail Bag

READER WHO THINKS WE MISSED THE MARK

Dear Editor:

Just recently I received from you a notice that my subscription is about to expire. Having been a subscriber to your publication for a number of years, I feel that I am entitled to at least one letter expressing my opinions. I hope that what I have to tell you will be accepted in the spirit of helpfulness rather than viewing it as just a gripe.

I am not a serviceman but I have built many sets. Radio design is my hobby and for my regular living I am an instructor at Mare Island Navy Yard.

I have always looked forward to my *Radio-Craft* in the past because it had a lot of good things in it to read which were very educational. Recently, however, it seems you have gone all out for the war and the articles you publish seem to cater more to the imagination than the real fundamentals.

All of us should study to better our futures as well as to more intelligently prosecute the war which we are forced to fight. Delving into the wonders of engineering phenomena from the top rung is not my idea of a proper approach in this direction. True, you have from time to time delved into the fundamentals but when the child began to toddle, more pressing business caused you to diverge in other directions,

to return at some belated date for a new try.

I have known quite a few radio servicemen in my time and their lack of fundamental knowledge is amazing. About all they know about a tube is that it is an 8-pronged gadget which makes music when placed in eight small holes in a chassis. GM to them might mean anything—General Motors, at first guess. When I attempt a discussion regarding inverse feedback, inverter circuits, or various types of detection, they tell me that all of this is unnecessary. All one needs to know is how to replace a defective part!

Yours has been the opportunity to carry on this education, but in this you have failed. As for myself, I am about to look for a more educational "mag" which deals more along the A. C. Shaney line.

You will please pardon me if I have been harsh but your recent trend in articles has cramped my style very much. But you can have, perhaps, a small amount of sympathy for one who propounds theory and then sees it all regarded so very lightly on all sides. When you again begin publishing educational matter, I will gladly send my check for a new round of *Radio-Craft*.

Thank you for the past when you had swelled things to read and study on.

F. C. NOLLE,
Vallejo, Calif.

AN ENTHUSIAST FROM AUDIOTRON DAYS

Dear Mr. Gernsback:

I'm not saying Editor because I feel I have known you for a long time; in fact, I have been reading your publication since 1920. At that time I was 13 years of age and had a licensed transmitter, home-made, ½ kilowatt spark and rotary spark gap. The receiver was a 1-tube audion. This tube had two filaments; if one burned out, you still had another. The terminal wires came straight out of the glass ends as there wasn't any socket. I suppose you remember them. Then C.W. came into existence. I couldn't afford the expensive tubes and parts, so I had to give it up, but I still do radio serv-

icing and make amplifiers, some of which I copied from *Radio-Craft* and found to work very well.

Besides doing radio servicing, I work for the Ferranti Electric Co. Ltd., Toronto, on X-ray machines. Wiring them up and also making timers for X-ray machines.

I haven't missed a *Radio-Craft* for some time and find myself waiting for the next issue impatiently. I have enjoyed articles on FM and amplifiers. I would enjoy some articles on electronic timing of high and low currents.

VINCE SHIPMAN,
Toronto, Canada

HE'S PLENTY TIRED OF ELECTRONICS

Dear Editor:

I have been a reader of *Radio-Craft* magazine ever since you have been printing it. I have got a lot of good from them, but since the war started I can't see that they are worth buying.

All you have is Electronics. I am plenty tired of this, as if you did want to make use of any of it, you couldn't get the parts anyway. Time for Electronics after the war!

I am a radio service man and have always looked on your magazine as a source of information. If a magazine ever needed to help keep the nation's radios going, it is now. For instance, you could furnish diagrams and conversion charts on tubes and other parts, replacement kinks, ways of salvaging or repairing tubes.

It is being done by companies—can't you throw any light on the construction of a filament welder? I am sure it would do more good to have one item like this than all the far-away stuff you have printed for a year.

So please straighten up and fly right.

WM. E. BREEDLOVE,
Bowling Green, Ky.

(We feel that some of Mr. Breedlove's criticism is a bit harsh. Particularly that part about no tube replacement material. *Radio-Craft* printed one of the earliest tube replacement charts, in July, 1942, before the tube shortage became acute, and followed it up by articles on tube replacements in February and June, 1943; another chart in July to supplement the earlier one; further articles on tube replacement theory and practice in May [two articles], and June, 1944. Supplementing these were numerous items on individual tube changes in the Technotes section.

A description of tube filament welding was given in the January 1944 Technotes. From the number of items on these welders sent in, we assumed that every serviceman in the country knew all about them. This may not have been the case, and a resumé is printed in this month's Technotes.—Editor)

RADIO-CRAFT for FEBRUARY, 1945

BOOK REVIEWS

MEN OF SCIENCE IN AMERICA, by Bernard Jaffee. Published by Simon and Schuster. Stiff cloth covers, 6 x 9 inches, 600 pages. Price \$3.75.

Despite the fact that progress in science and industry is one of the decisive factors in the development of any country, scientists receive little attention in most standard histories. This is probably truer of the United States—where scientific progress is taken for granted, as a natural law—than of many other countries. Economic history is often the closest approach to a real account and evaluation of the lives of our men of science.

As pointed out in the Foreword, the history of science is international, and any attempt to write a history of science in America would be an absurdity. The author therefore has cast his work in a biographical mold, selecting the lives of nineteen individuals prominent in advancing human knowledge in the American field. Around the work of these individuals he has woven the general advance of science, both here and throughout the world.

Of the nineteen characters reviewed, five are physicists, five naturalists, and four in the field of biology and medicine. Of these, the Boston dentist Morton is introduced not so much on account of his own qualifications as to carry the story of the development of anesthesia. Students of the earth and its surroundings number three, the hydrographer Matthew Fontaine Maury, the geologist Dana and the astronomer Hubble. A chemist and a paleontologist complete the list.

The book's concluding chapter, "The Future of Science in America" is a plan and a program for the advancement of science and its utilization for the common good.

ELECTRONICS FOR BOYS AND GIRLS, by Jeanne Bendick. (With a foreword by Keith Henney.) Illustrations by the author. Published by Whittlesey House. Stiff cloth covers, 5½ x 8 inches, 148 pages. Price \$1.50.

A simplified work on the more elementary phases of electron activity, this book is aimed roughly at the juvenile audience of ten years and upward. While generally the author's aim has been good, there are a number of places where the technical level is well above that of the language used, and many others where the youthful reader's "Why?" remains unanswered. The mysterious force (or is it a substance?) referred to as voltage, is never fully explained, for example.

The description and drawings of electron movement in wires and vacuum are well done and should convey to the mind of any reader a clear, if incomplete, idea of how electrons travel.

After three introductory chapters, the beginnings of electricity 2,600 years ago are traced to a point 50 years from the present, where electricity commences to blend into electronics. Two chapters, on waves and vacuum-tube action, follow. Then the young reader is taken on a tour of the various electronic apparatus in the present-day world. This features rather successful attempts to explain such complex devices as the electron microscope and television's Iconoscope.

OFF MIKE, Radio Writing by the Nation's Top Radio Writers. Edited by Jerome Lawrence. Published by Essential Books. Stiff cloth covers, 5½ x 8 inches, 195 pages. Price \$2.50.

"Off Mike" is a book about radio writing—not the kind of radio writing the technician expects, but stuff designed to go through the broadcast station microphone. A symposium by some of the best writers in the business, it includes angles on all parts of the game, from producing gags to writing for television. The reader is strictly warned that this is not a "How to Do It" book, simply because no such book on radio writing can be produced. The intelligent reader will however find many valuable hints in its pages.

Four articles are devoted to radio humor. They are authored by such writers as Sherwood Schwartz, Bill Morrow, Don Quinn and Abram Burrows, writers for the Bob Hope, Jack Benny, Fibber McGee and Duffy's Tavern programs respectively. Three articles on radio drama follow with Norman Corwin, Arch Oboler and True Boardman as authors.

The other subjects, with the exception of the series show, receive one article apiece. Serials are good for three, including one by Gertrude Berg of the veteran Goldbergs. Other subjects include staff writing and continuity, radio adaptations, news writing and news commentary, writing for children, wartime programs (including an article by the book's editor) and writing for television.

RADIO FUNDAMENTAL PRINCIPLES AND PRACTICES, by Francis E. Alstead, Kirke E. Davis and George K. Stone. Published by McGraw-Hill Book Co. Stiff cloth covers, 5½ x 8 inches, 219 pages. Price \$1.80.

Conciseness is the key-note of this book. Revised constantly during six years while being used in the mimeographed form, it has been worked into what the authors consider the most useful, accurate and teachable form.

The material was originally used in high-school classes, in evening classes for adults and in the training of naval recruits. A knowledge of high school physics and some ability in elementary algebra are presupposed. A surprising amount of information is given in spite of the brevity of the book, and it may be seen that the authors' boast of conciseness is well-founded. A good teacher would have little difficulty in making the book the basis of a first course in radio, though there is not enough matter in it for self-study.

The illustrations are selected and reduced to their simplest forms with the same care as the words. Some of them, notably the drawings of meters and of microphones, are outstanding in their clear presentation of the subject in the fewest possible lines.

Although devoted to fundamentals, the subject matter includes matter on transmitters, distortion in amplifiers and modulators, wave propagation and transmission lines.

Very brief descriptions of the difference between amplitude and frequency modulation are given, and the principles of television explained with equal brevity, as also is the transmission of facsimile.

NOW—A REALLY HIGH-POWERED— Radio Engineering Library

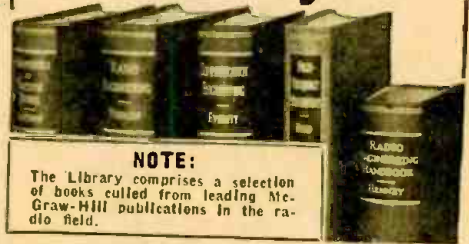

NOTE:
The Library comprises a selection of books culled from leading McGraw-Hill publications in the radio field.

- especially selected by radio specialists of McGraw-Hill publications
- to give most complete, dependable coverage of facts needed by all whose fields are grounded on radio fundamentals
- available at a special price and terms

THESE books cover circuit phenomena, tube theory, networks, measurements, and other subjects—give specialized treatments of all fields of practical design and application. They are books of recognized position in the literature—books you will refer to and be referred to often. If you are a practical designer, researcher or engineer in any field based on radio, you want these books for the help they give in hundreds of problems throughout the whole field of radio engineering.

5 VOLUMES, 3319 PAGES, 2289 ILLUSTRATIONS

1. Eastman's FUNDAMENTALS OF VACUUM TUBES
2. Terman's RADIO ENGINEERING
3. Everitt's COMMUNICATION ENGINEERING
4. Hund's HIGH FREQUENCY MEASUREMENTS
5. Henney's RADIO ENGINEERING HANDBOOK

10 days' examination. Easy terms. Special price under this offer less than books bought separately. Add these standard works to your library now; pay small monthly installments, while you use the books.

10 DAYS' FREE EXAMINATION—SEND COUPON

McGraw-Hill Book Co., 330 W. 42nd St. New York 18

Send me Radio Engineering Library, 5 vols., for 10 days' examination on approval. In 10 days I will send \$3.00, plus few cents postage, and \$2.00 monthly till age is paid, or return books postpaid. (We buy post-shipment.)

Name

Address

City and State

Position

Company RC 2-45

MATHEMATICS FOR RADIO

Two volumes, prepared for home study. Book I (314 pp.) covers the algebra, arithmetic, and geometry; Book II (329 pp.) covers the advanced algebra, trigonometry, and complex numbers necessary to read technical books and articles on radio.

MAEDEL PUBLISHING HOUSE Room 117
593 East 38 Street, Brooklyn, New York

Send me MATHEMATICS FOR RADIO AND COMMUNICATION as checked below. I enclose payment therefor with the understanding that I may return the book(s) within 5 days in good condition and my money will be refunded.

Name

Address

- Book I at \$3.75 plus 6c postage
- Book II at \$4.00 plus 6c postage
- Books I and II at \$7.75 postage prepaid

Foreign and Canadian prices 25c per volume higher

RADIO SCHOOL DIRECTORY

PREPARE NOW FOR POST-WAR RADIO AND ELECTRONICS

MAKE a place for yourself in a new world of radio and electronics—a world in which revolutionary electronic developments will require highly specialized technical knowledge. Take a good course now to fit yourself for a good paying job. The training you need can be supplied by one of the schools advertised in this publication.

RADIO-TELEVISION ELECTRONICS

offer ever-increasing post-war opportunities for trained men and women. R-T courses prepare you by combining theory with practical laboratory experience.

Consideration given to Veterans eligible for training under the G. I. Bill. Day & Evening Sessions. Apply daily 9-9. Sat. 9-2. Request Information.

Radio-Television Institute

480 Lexington Avenue, N. Y. 17 (46th St.) PLaza 3-4585 Licensed by N. Y. State

Pre-Induction RADIO COURSES

for Civilians and those entering Military Services. New classes now starting for men and women.

• RADIO OPERATING — CODE
• RADIO SERVICING — ELECTRONICS
New York Y.M.C.A. Schools
4 W. 64th Street New York City

COMMERCIAL RADIO INSTITUTE

A radio training center for twenty-four years.

ACCREDITED FOR VETERAN TRAINING RESIDENT COURSES ONLY

Pro-Induction, Broadcast, Service, Aeronautical, Television and Marine telegraphy classes now forming for February 5th. Literature upon request.

Home Study Course in Mathematics
Dept. C., 38 West Biddle St., Baltimore 1, Md.

CODE SENDING RECEIVING SPEED

Be a "key" man. Learn how to send and receive messages in code by telegraph and radio. Army, Navy and Commerce need thousands of men. Good pay, adventure, interesting work. Learn at home quickly through famous Candler System. Write for FREE BOOK.

CANDLER SYSTEM CO.
Dept. 3-B, Box 928, Denver 1, Colo., U.S.A.

• • • LOOK AT THE CAPITOL RADIO ENGINEERING INSTITUTE MESSAGE ON PAGE 306.

\$3.00 FOR YOUR CARTOON IDEAS

RADIO-CRAFT, as you will have noticed, prints a number of radio cartoons, which we intend to keep on publishing every month indefinitely. We invite our readers to contribute to this feature by sending in their ideas of humorous radio ideas which can be used in cartoon form. It is not necessary that you draw a sketch, but you may do so if you so desire.

RADIO-CRAFT will pay \$3.00 for each original idea submitted and accepted.

We cannot return ideas to this department nor can we enter into correspondence in connection with them. Checks are payable on publication.

Address all entries to RADIO CARTOONS, c/o RADIO-CRAFT, 25 West Broadway, New York 7, N. Y.

RADIO ELECTRONICS



Intensive training in Airline, Merchant Marine, Press Communications, Electronics, Television. Co-educational. FREE booklet.

VETERANS: Request FREE copy, G.I. bill of rights

"A Radio School managed by radio men."
45 W. 45th St., Dept. RC, New York 19, N.Y.
MELVILLE RADIO INSTITUTE

RCA INSTITUTES

Offer thorough training courses in all technical phases of

Radio and Television

DAYS-EVENINGS WEEKLY RATES

VETERANS: RCA Institutes is approved under G. I. Bill of Rights

For Free Catalog Write Dept. RC-45

RCA INSTITUTES, Inc.

A Radio Corporation of America Service
75 VARICK STREET NEW YORK 13, N. Y.

Correspondence Courses in RADIO and ELECTRICAL ENGINEERING

ELECTRICAL ENGINEERING Get good grasp of wide electrical field. Prepare yourself at Low Cost for secure future. Modern, simplified, you can understand quickly.
RADIO ENGINEERING Extra fine course in radio, public address, photo-electric work.
Train you to be super-service man, real vacuum tube technician. Servicemen needed badly. Diploma on completion. Tuition \$25, either course. Deferred payment plan. Get copies of school catalog, student magazines, complete details. SEND NOW!
FREE LINCOLN ENGINEERING SCHOOL Box 931C-72 Lincoln, Nebr.

RADIO ENGINEERING I

EX-SERVICE MEN can complete work here in shortest possible time. Special Prep. Dep't. Also REFRESHER COURSES. Courses also in Civil, Electrical, Mechanical, Chemical, Aeronautical Engineering; Business Administration, Accounting, Secretarial Science. Tuition, living costs low. 61st year. Cosmopolitan student body. Enter Mar., June, Sept., Jan. Catalog. 2425 College Ave. ANGOLA, INDIANA

TRI-STATE COLLEGE

★ BUY AN ★
★ EXTRA WAR BOND ★
★ ★

SUPER PHOTO-TIMER

(Continued from page 276)

on the phototube camera assembly varies the voltage between the eighth and ninth dynodes through a resistor and may be locked by means of the lock nut.

Initiation of the exposure occurs on closing the exposure switch. A current flows in the phototube circuit, creating a potential across a resistor and capacitor. The resistor is included to compensate for the relay drop-out time—about 1/60 of a second. The trigger tube fires at 70 volts and its resulting plate current energizes a relay which opens the main X-ray contactors in the X-ray control and ends the exposure. In preparation for the next exposure, a shorting relay by-passes to ground any charge left on the condenser.

THE SAFETY CIRCUIT

A safety timer, consisting of a trigger tube, an adjustable resistance, a condenser, two relays, and a buzzer, protects the X-ray unit against any failure of the unit and against excessively long exposures which might exceed the rating of the X-ray tube and cause damage to it. A relay opens the X-ray transformer primary before exposure time reaches the danger point. The safety unit is mounted in a case with the power supply for the phototube camera. A complete schematic is seen in Fig. 2.

The value of miniature chest photofluorography, rendered more efficient by the phototimer which insures uniform exposures, lies not only in conserving manpower by finding the tubercular individual while he can still be easily cured, but also in finding thousands of totally unsuspected carriers of disease who are spreading tuberculosis.

Since the cost of 14 x 17 X-ray film was a limiting economical factor in mass surveys, a method which decreased cost was necessary. The use of miniature films on rolls already represents a considerable economy, for the film cost of such an exposure is one cent as against sixty cents for a 14 x 17 film. The phototimer contributes a further saving because a given crew of technicians can handle twice as many subjects as heretofore—a 100 per cent increase in efficiency—and because uniform exposure is obtained regardless of internal variations, eliminating repetitions.

The industrial application of the electronic timer should be as effective for the same reasons. Whether similar objects are moving rapidly on a conveyor or whether a variety of irregular objects must be X-rayed, the electronic timer will provide uniform exposures quickly and efficiently.

The phototube camera is seen at the right, with the power supply and safety timer—housed in a single unit—at the left. F. J. Euler, Jr., J. E. Kalstein and C. T. Zavales are discussing safety-unit design.



No Tools Required to Install These ATTACHABLE SWITCHES for Mallory Volume Controls

THEY'RE easier to install than any other "off-on" snap switch—no tools are required to attach them to volume controls! That's why so many service men prefer to use Mallory Attachable Switches.

The Mallory switch designed for controls of 1½" diameter fits Mallory standard universal controls, carbon and wire-wound types, TRP tapped controls and Universal





dual controls. The Mallory switch designed for 1¼" diameters fits Mallory MR, MK, UM, TM and DTM controls.

Both may be rigidly mounted without any bending or alteration of the volume controls.

Both are available in circuit arrangements to suit *any* type of application. See your Mallory distributor!

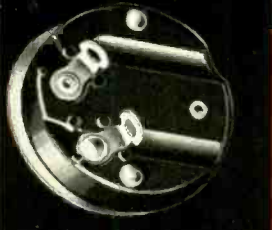
P. R. MALLORY & CO., Inc., INDIANAPOLIS 6, INDIANA

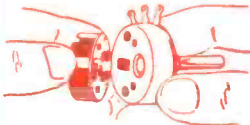
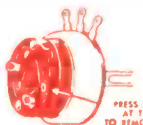

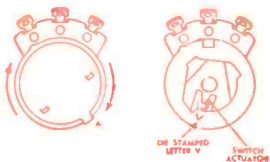
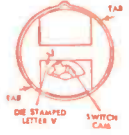
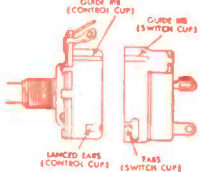
<p>For 1½" Diameter Controls</p>  	 <p>To attach switch, remove dust-proof plate from back of control.</p>  <p>ACTUATING ARM</p> <p>Turn shaft as far as it will go in clockwise direction.</p>  <p>Make sure switch actuating arm is in proper position, as pictured.</p>  <p>PRESS AND RAISE AT THIS POINT TO REMOVE SWITCH</p> <p>Insert tongue of switch into long slot. Press down, slide up slightly and switch will snap into place. Move back slightly to lock.</p>	<p>For 1¼" Diameter Controls</p>  	 <p>Remove cover. Line up switch actuator of volume control with Letter V.</p>  <p>Line up switch cam with Letter V.</p>  <p>Line up guide rib on switch and on control as shown, press switch down tightly until switch tabs snap over ears on control cup. To remove switch, bend up ears.</p>
--	---	--	---

More than ever—
**ALWAYS
INSIST ON**

P. R. MALLORY & CO. Inc.
MALLORY
APPROVED
PRECISION PRODUCTS

VIBRATORS • VIBRAPACKS* • CONDENSERS
VOLUME CONTROLS • SWITCHES • RESISTORS
FILTERS • RECTIFIERS • POWER SUPPLIES

ALSO MALLORY "TROPICAL" DRY BATTERIES, ORIGINALLY DEVELOPED BY MALLORY FOR THE U. S. ARMY SIGNAL CORPS, NOT PRESENTLY AVAILABLE FOR CIVILIAN USE.

®Trademark

We haven't
the brand
you want -
but we have
BLANKOS

CIGARETTES



Never heard
of them - but
okay - I have
to take
what I can
get

**You gotta smoke
- even if it's cornsilk**

It goes in the radio service business, too. • We don't blame you for taking what you can get, Mr Radio Service Man. • We know you are a business man and that you have a job to do. We understand why you have to accept spot merchandise in a pinch like this. • We also believe, however, that you think along sound lines, that you really want **BRANDED**

MERCHANDISE, and that ordinarily you depend on the reputation of the manufacturer who stands back of that merchandise. • Uncle Sam, who is the most careful of buyers and who thinks about reputations, has drafted IRC Resistors and Controls. That leaves us leaving you out on a limb. (Remember -- scarcity, these days, is a mark of leadership!)

I'll be glad when I can quit selling foot-in-the-door merchandise, and get back to IRC



• Most people are fed up with substitutions. They've had too much oleo-margarine, too many ersatz non-elastic girdles, and cigarettes with unheard-of names. Just as soon as they can, they want to get back to real things -- dependables. • We hope that goes for you and IRC Resistors and Controls. It looks now as if things might ease up soon -- and we could again build on quality together.



INTERNATIONAL RESISTANCE CO.

DEPT. 25-B 401 N. BROAD ST. • PHILADELPHIA 8, PA.

IRC makes more types of resistor units, in more shapes, for more applications than any other manufacturer in the world.



ADV Plans, LLC

Copyright Notice:

The entire contents of this CD/DVD are copyright 2014 by ADV Plans, LLC. All Rights Reserved.

Reproduction or distribution of this disk, either free or for a fee is strictly prohibited. We actively monitor and remove listings on eBay thru Vero.

You are free to copy or use individual images in your own projects, magazines, brochures or other school projects.

Only the sellers listed here are authorized distributors of this collection:
www.theclassicarchives.com/authorizedsuppliers

Please view our other products at
www.theclassicarchives.com,
or our ebay stores:

[TheClassicArchives](#)
[ADVPlans](#)
[SuperShedPlans](#)

